



OPTIMA
5/8, 4/10, 4/8, 4/4, 3/12-180,
3/10-180 3/7-180, 2/10-180
Circulation Pump
Operating Instruction

1. CAUTION.....	1
2. WARNINGS AND SYMBOLS.....	1
2.1 Types of Symbols and Warnings.....	1
3. GENERAL.....	2
3.1 Description of the Pump.....	2
3.2 Applications (Intended Use).....	3
3.3 Pumped Liquids.....	3
3.4 Operating Conditions.....	3
3.5 Insulation Shells.....	4
4. CONTENTS OF THE PACKAGE, LIFTING, TRANSPORTATION AND STORAGE.....	4
4.1 Contents of the Package.....	4
4.2 Lifting.....	4
4.3 Transportation and Storage.....	5
5. PUMP DETAILS.....	5
5.1 Nameplate.....	5
5.2 Technical Data.....	6
6. PUMP INSTALLATION.....	7
6.1 Positioning.....	7
6.2 Mechanical Installation.....	9
6.3 Filling and Venting.....	11
6.4 Cable/Fuse Selection and Electrical Installation.....	11
6.5 Parallel/Back-up Operation.....	14
7. DISPLAY AND SETTINGS.....	15
7.1 Graphical Display.....	15
7.2 2-Digit Display.....	18
8. FIRST START-UP, CONTINUOUS OPERATION AND SHUTDOWN.....	20
9. OPERATING MODES AND SELECTION CRITERIA.....	21
9.1 Manual Operating Mode.....	22
9.2 Constant Pressure Operating Mode.....	22
9.3 Variable Pressure Operating Mode.....	23
9.4 Operating Mode Selection Criteria.....	25
10. ADDITIONAL ACCESSORIES.....	26
11. WARRANTY, MAINTENANCE AND SERVICE.....	26
12. FAULTS, CAUSES AND REMEDIES.....	27
13. DISMANTLING.....	32
14. DISPOSAL.....	33
15. APPENDIX.....	34
15.1 Dimensions.....	34
15.2 General Selection Chart and Performance Curves.....	35

1. CAUTION

Read this manual carefully. The information given here comprises essential issues which is required for the pump operators or users.

CAUTION

If you need any information later on, please refer to this manual

The manufacturer of the Optima pumps, Alarko-Carrier, provides customer service and retailing operations on the fields of heating, cooling, ventilation, water treatment and pressurization nationwide with its 68 years of experience. Please contact your authorized Alarko-Carrier customer service if you need any information or encounter a problem.

The details in the following pages apply to Optima 5/8, 4/10, 4/8, 4/4, 3/12-180, 3/10-180 3/7-180, 2/10-180 types.

2. WARNINGS AND SYMBOLS

This appliance can be used by children aged from 8 years and above and persons with reduced physical, sensory or mental capabilities or lack of experience and knowledge if they have been given supervision or instruction concerning use of the appliance in a safe way and understand the hazards involved. Children shall not play with the appliance. Cleaning and user maintenance shall not be made by children without supervision.

2.1 Types of Symbols and Warnings



If these warnings are not taken into account, it may result in death or injury.



If these warnings are not taken into account, serious injuries or death may occur due to electric shock.

CAUTION

If these warnings are not taken into account, safe operation or the protection of the pump may fail.

3. GENERAL

3.1 Description of the Pump

Alarko Optima is a brand new type of circulation pump which regulates its speed according to the system needs by the ECM (Electronic Commutated Motor) technology and the controller on it, as well as saves energy with its various types of operating mode choices. The operating modes are manual, constant pressure and variable pressure. See section 7.1.1, 7.2.2 and 9. The pump operates according to the operating mode and head settings which are set from the controller.

The main components and their materials are given in the following figure and table.

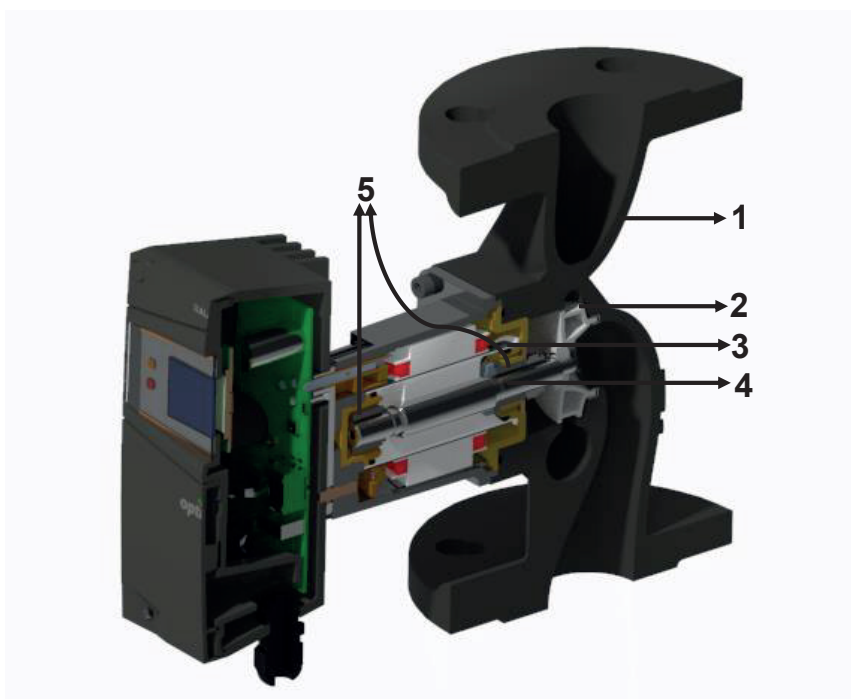

Figure 3.1: Cross-section Drawing of the Pump

No	Component	Material
1	Pump housing	Cast iron (EN-GJL-200)
2	Impeller	Plastic (modified PPO - %30 GF)
3	Rotor can	Composite
4	Shaft	Stainless steel (1.4021 or 1.4034)
5	Bearings	Carbon (metal impregnated)

Table 3.1: List of the Main Components

3.2 Applications (Intended Use)

Alarko Optima pumps are developed for the circulation and pressurization of the water flowing in the heating and air conditioning systems located in the residential, commercial and industrial establishments.

CAUTION

Optima pumps can be used only for the purposes that are stated in this manual. The manufacturer and the dealer are not responsible for the results of the misuse.

3.3 Pumped Liquids

As the liquid, only water should be used. It should be free from solid particles and is not mixed with any additives, e.g. anti-freeze. To avoid any kind of scaling or corrosion, the water within the system should meet the criteria below:

Total Heating Output [kW]	Sum of Alkaline Earths [mole/m ³]	Total hardness [°d]	pH value at 25°C	Oxygen [mg/liter]	Electrical Conductivity at 25°C [µS/cm]
... ≤ 50	≤ 3.0	≤ 16.8	8.2 – 10.0	< 0.02	< 100
50 < ... ≤ 200	≤ 2.0	≤ 11.2			
200 < ... ≤ 600	≤ 1.5	≤ 8.4			
600 < ...	≤ 0.02	≤ 0.11			

Table 3.2: Properties of the water used in heating systems¹

¹Source: VDI 2035 – Part 1 and 2

3.4 Operating Conditions

Alarko Optima pumps are developed for the circulation and pressurization of the water flowing in the heating and air conditioning systems located in the residential, commercial and industrial establishments.

Input Voltage: Single Phase 230 Volts AC (± 10%) and 50 Hz (earth protected).

Water Temperature: Up to +110°C

System Pressure: For minimum and maximum water pressure see Table 4.2 and Table 4.3

Ambient Temperature: -10°C to +40°C



The conditions (voltage, pressure, temperature) of the pump while operating should be between the limits given above.

3.5 Insulation Shells

The insulation shell is designed to mitigate the thermal losses in heating systems and delivered with the pump. It is made of polypropylene foam and thoroughly mounted on the pump by its perfectly fitting design.

Remove the insulation shells from the housing before the pump installation. See Figure 3.2.



Figure 3.2: Insulation Shells

4. CONTENTS OF THE PACKAGE, LIFTING, TRANSPORTATION AND STORAGE

4.1 Contents of the Package

The package contains the following:

- Pump
- Insulation shells
- Manual
- Certificate of Warranty
- 2 pieces of gasket (for 5/8, 4/10, 4/8, 4/4 pump types)
- 1 piece of O-ring (used between pump housing-motor housing)

CAUTION

Do not throw away the insulation shells.

4.2 Lifting

The pump should be lifted from the pump housing.



Do not lift the pump from the controller box.



Lift the pump by observing the local lifting and handling regulations.

4.3 Transportation and Storage

Ambient Temperature during the Transportation and Storage: -25°C to +40°C

The pump should be protected from moisture, impacts and frost during the transport and storage.

CAUTION

Improper transportation or storage may lead to damage to the product.

It is advised to check and examine the product whether it is the ordered type and delivered undamaged.

If the pump is damaged or deformed, it should not be used without an approval of the Alarko-Carrier customer services.

5. PUMP DETAILS

5.1 Nameplate

The information given in the nameplate is shown below:

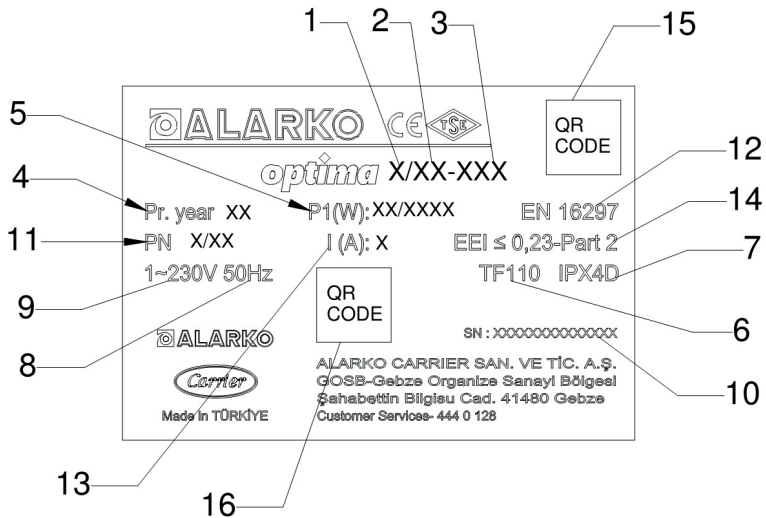

Figure 5.1: Sample of a Nameplate

Number	Description
1	First digit of the nominal flange diameter
2	Max. head
3	Pump housing length
4	Production year
5	Min. and Max. power
6	Temperature class
7	Enclosure class
8	Input frequency
9	Input voltage
10	Serial number
11	Max. system pressure
12	Acquired standards
13	Max. current
14	Energy Efficiency Index (EEI)
15	Operating Instruction Link
16	Factory Manufacturing Code

Table 5.1: Description of the Nameplate Data

5.2 Technical Data

	5/8	4/10	4/8	4/4	3/12-180	3/10-180	3/7-180	2/10-180
Max. Head [m]	According to pump type, see Appendix							
Max. Flow [m³/h]	According to pump type, see Appendix							
Speed [rpm]	1800 – 4600	1800 – 4600	1800 – 4600	1600 – 3600	1800 – 4900	1800 – 4600	1600 – 3800	1800 – 4600
Input Voltage and Frequency	1~ 230 V AC ± %10, 50 Hz, PE							
Nominal Current [A]	1.35	1.4	1.35	1	1.34	1.4	1	1.4
Power Consumption [W]	15 – 300	12 – 190	15 – 300	12 – 125	16 – 300	12 – 190	12 – 125	12 – 190
Energy Efficiency Index (EEI)	≤ 0.23							
Insulation Class	F							
Enclosure Class	IP X4D							
Temperature Class	TF 110							
Max. System Pressure	PN 6/10 ⁽¹⁾				PN10			
Emitted sound pressure	< 56 dB							
Relative Humidity	< %90							
Pump Dimensions	see Appendix							

⁽¹⁾ Pump is suitable for both pressure values.

Table 5.2 Technical Data

In order to avoid the noise and damage due to the cavitation, the minimum inlet pressure values are given on the table below.

Nominal Diameter	Water Temperature			
	50°C	75°C	95°C	110°C
G1 1/2"	0,4 bar	0,7 bar	1,0 bar	1,5 bar
G2	0,4 bar	0,7 bar	1,0 bar	1,5 bar
DN40	0,5 bar	0,8 bar	1,3 bar	2,0 bar
DN50	0,5 bar	0,8 bar	1,3 bar	2,0 bar

Table 5.3: Minimum Inlet Water Pressure Values

CAUTION

The values listed in the table apply to pumps installed up to 300 meters above sea level. For higher altitudes add +0.01 bar/100m to the required relative inlet pressure.

6. PUMP INSTALLATION



Mechanical and electrical installation must be carried out by qualified personnel and in accordance with the instructions on this manual and also with applicable regulations.

CAUTION

Before any installation, the pipework should be checked for contamination and flushed if there is any.

6.1 Positioning



The pump should be installed into the pipework without any strain or bearing the weight of the pipework.

The figures given below are to be taken into consideration during the installation.

The pump must be connected to the pipework without any strain, do not bear the weight of the pipework and the motor shaft must be parallel to the ground.

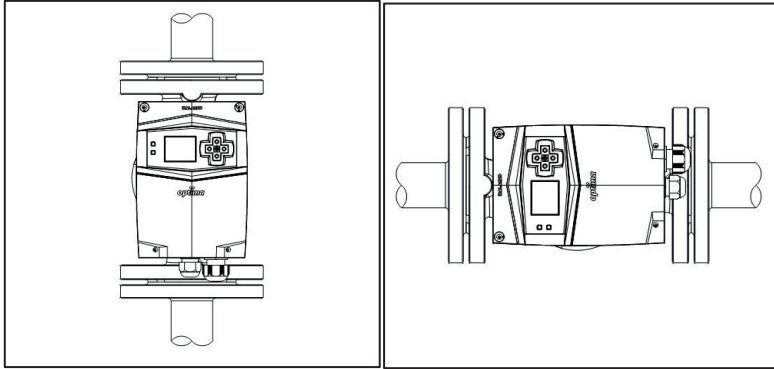

Figure 6.1: Correct Pump Positions While Vertically and Horizontally Installed to the Pipework

The pump must be not perpendicular to the ground.

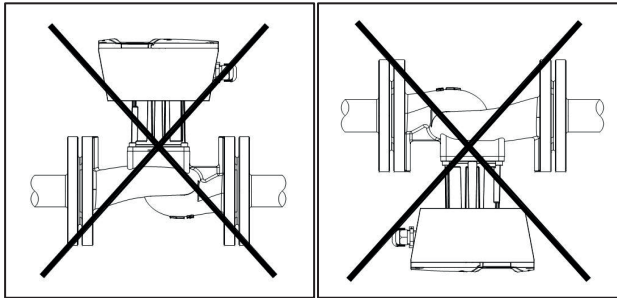

Figure 6.2: Incorrect Pump Positions

The position of the control box can be changed in order to see and use the display easier. To adjust the position, the 4 bolts, which hook the motor housing and pump housing together, are removed and the motor housing is adjusted by rotating it to the appropriate one from the allowed positions and reconnected to the pump housing with bolts.



Do not separate the motor housing from pump housing. Rotation operation should be done carefully and slowly. Seal damage causes leakage.

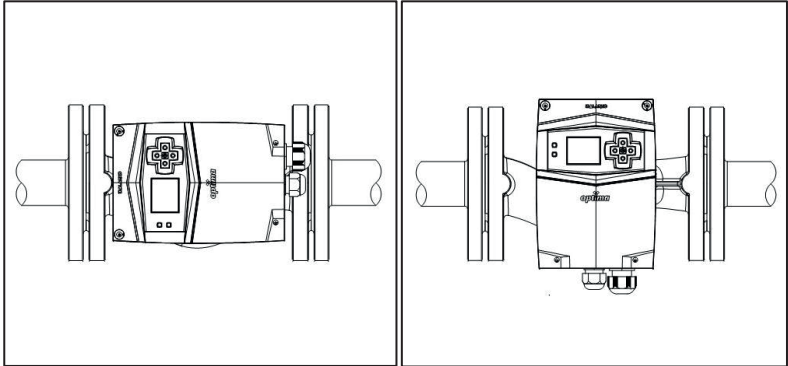

Figure 6.3: Control Box Position Adjustment

6.2 Mechanical Installation

1. Make sure that all the piping of the system must be done before beginning the installation.
2. Close the valves on the inlet and outlet side to isolate the pump from water flow.
3. Check the coherence of the system pressure and the min. & max. pressure values of the pump. See Section 5.2.
4. Mount the pump to the pipes while taking the arrow on the pump housing into consideration. The water flow of the system and the arrow on the housing must be in the same direction.
5. For threaded pipe connection; place the flat gaskets onto the sides of the pump. Make sure that the gaskets do not prevent any water flow.
6. Using a strap wrench or spanner, hold the pump from the pump housing and screw the nuts. See Figure 6.4



Figure 6.4: Threaded Pipe Connection

7. For flanged pipe connection; place the supplied flat gaskets onto both sides of the pump. Make sure that the gaskets do not prevent any water flow.
8. Use the washers, bolts and nuts given in the Table 6.1 to fix the pump to the pipes.

- Check the Figure 6.5 for washer, bolt and nut order. See Table 6.1 for the recommended tightening torques for the bolts used in the pump fixing.

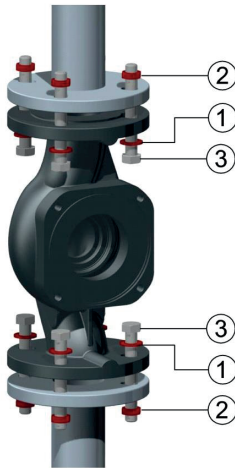

1	Washer
2	Nut
3	Bolt

Figure 6.5 Flanged Pipe Connection

Pressure	Bolt and Nut Type	Recommended Tightening Torque Value
PN 6	M12	40 Nm - 60 Nm
PN 10	M16	70 Nm - 90 Nm

Table 6.1 Recommended Tightening Torque Values

- After completing the connection, open the isolating valves of inlet and outlet sides and check if there is any leaking.
- Make sure that the four condensate drain grooves around the pump are open. See Figure 6.6.

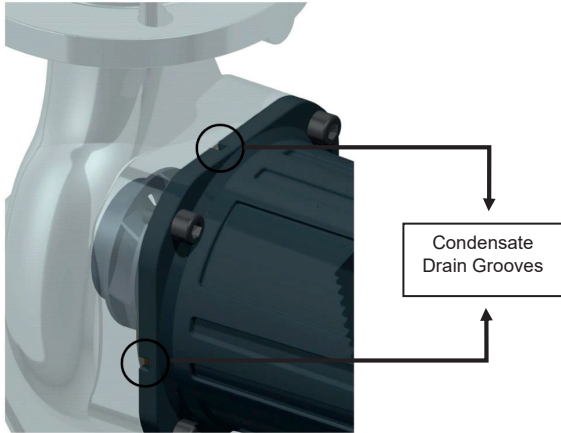

Figure 6.6: Condensate Drain Grooves

12. After the installation is completed, place the insulation shells as shown in Figure 6.7.



Figure 6.7: Placing the Insulation Shells

6.3 Filling and Venting

In order to ensure the pump to operate efficiently also without any damage and noise, the air in the system must be vented and the system pressure must be between the values given in Table 5.2 and Table 5.3. To fully vent the air from the system, the pump can be run for a while.



Air venting should not be done by loosening any bolts of motor or pump housing.

6.4 Cable/Fuse Selection and Electrical Installation



Electrical installation must be carried out by qualified personnel and in accordance with the instructions on this manual and also with applicable regulations.



Before working on the pump, all poles of the power supply must be disconnected.



The mains connection must have an earthing system. If not, the pump should not be run.

For cable and fuse selection, Table 6.2 should be considered.

	5/8	4/10	4/8	4/4	3/12-180	3/10-180	3/7-180	2/10-180
Cable	3 x 1.5 mm ²							
Fuse	2A							

Table 6.2: Cable and Fuse Values

Electrical connection diagram is given at Figure 6.8.

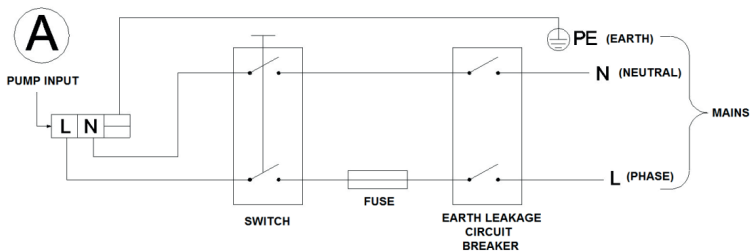

Figure 6.8: Electrical Connection Diagram

1. Check the phase and neutral outlets of the mains.
2. Attach cable ferrules to the cable tips appropriate to the cable diameter.
3. Take out the cover of the cable gland.
4. Remove the screws of the bottom cover. See Figure 6.9.

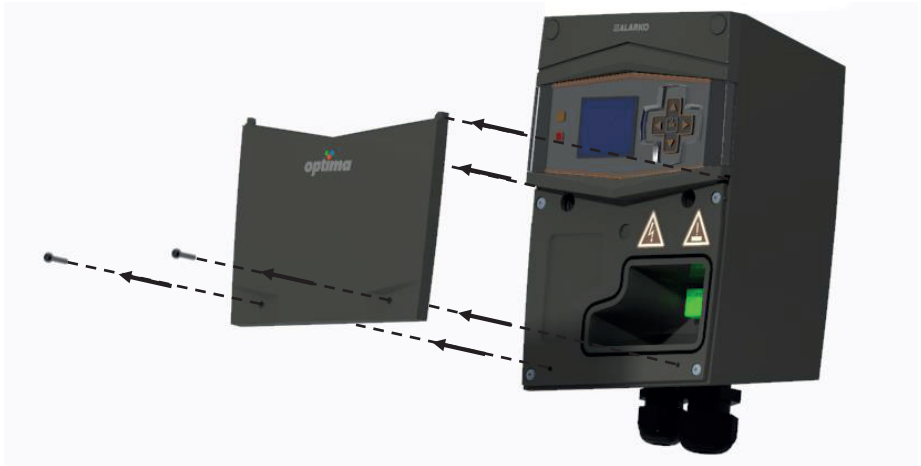

Figure 6.9: Removal of the Bottom Cover

5. Pull the power supply cable through the no.1 cable gland shown in Figure 6.10.

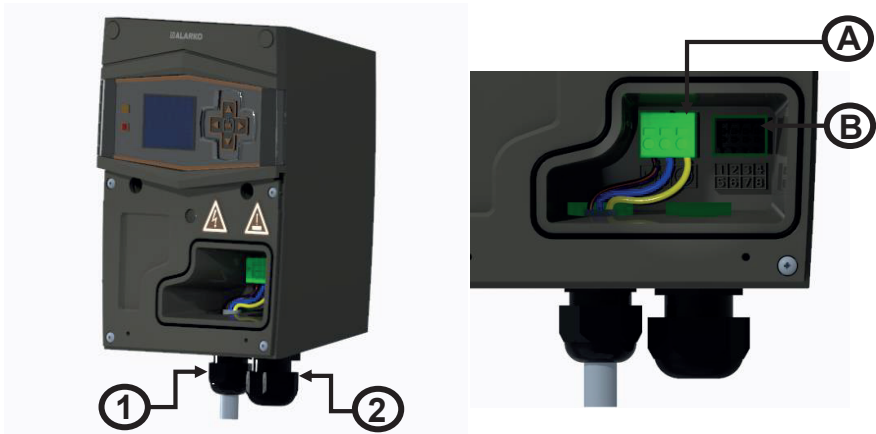

Figure 6.10: Cable Gland View

6. Connect the power supply cables to the socket named as "A" in Figure 6.10 appropriately, as shown in Figure 6.8.
7. Tighten the cable gland and make sure that the connection side of the cable is loose enough.
8. Refit the cover. See Figure 6.11.

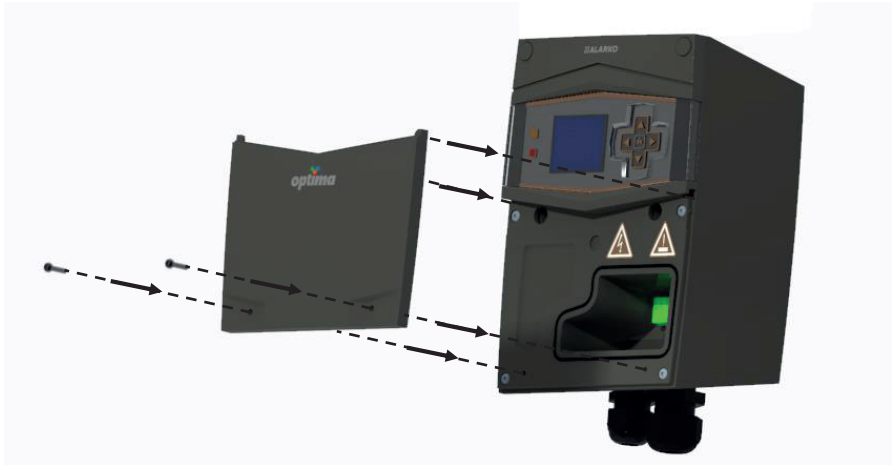

Figure 6.11: Refitting the Bottom Cover



The power cable should not be in contact with the pump or pipeline.



The voltage value of the mains must be in between the limits given in Table 5.2

It is recommended to use a residual-current device (RCD) to protect the user and the pump. The RCD should be chosen according to the nominal voltage and current of the pump and it should be able to trip on high frequency leakages (type B) (The tripping current should be lower than 3.5mA according to the EN 60335).

6.5 Parallel/Back-up Operation

Whereas the CCM module is not operating or inactive, when installing more than one pump for back-up or parallel operation, a check valve must be connected for each pump.

7. DISPLAY AND SETTINGS

The control display shows the information about the pump status and allows the user to set the desired mode to operation. Optima pumps have 3 different display options which are graphical display, 2-Digit and non-display.

7.1 Graphical Display

The graphical display has 2 LEDs, five control buttons and one TFT screen. See Figure 7.1.

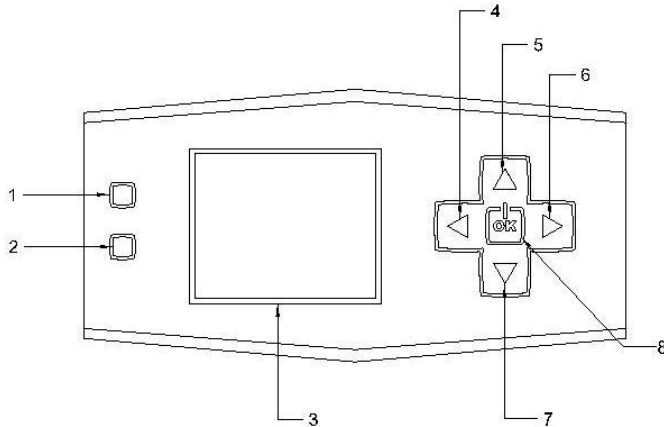
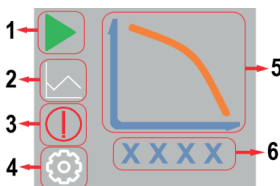

Figure 7.1 : Control Display Layout of Graphical Display

The layout of the buttons and display:

1. Remote Control LED (YELLOW): It blinks when getting a signal from the building automation system.
2. Fault LED (RED): It is on when there is a fault. It blinks when there is a warning.
3. TFT Display: Shows the operating modes and warning/error messages.
4. “Left” Button
5. “Up” Button
6. “Right” Button
7. “Down” Button
8. “OK” Button: To navigate through the menu.

The main menu is shown below:



- Nu. 1 shows the “Start/Stop” icon which use for start/stop and pause the pump.
- Nu. 2 shows the “Operating Mode Adjustment” icon that open the operating modes user interface.
- Nu. 3 shows the “Fault” icon. It is appearing when warning/error occurred that gives the information about fault codes.
- Nu. 4 shows the “Remote Control” icon that appears on the screen during the pump is integrated with the building operating system.
- Nu. 5 shows the pump operating modes in graphical view.

- Nu. 6 shows the current speed of the pump.

In the main menu; it is switching between operating modes and pause the pump with the “OK” button and direction keys.

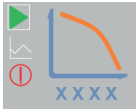

A white frame appears on the active icon in order to easily switching between the menus and submenus.

7.2.1 Start / Stop



When the pump is in operation, the pump is stopped by pressing the "OK" button once on the main screen on the "Start/Stop" icon.

The stopped pump is restarted by pressing the "OK" button.

7.2.2 Operating Modes



To adjust the operating modes, arrive upon the “Operating Mode Adjustment” icon by using the “Up” and “Down” buttons.

The “Operating Mode Setup” icon is the icon shown by the line graph below the “Start/Stop” icon.

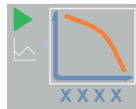

While upon the “Operating Mode Adjustment” icon” press “OK” button to select the graphical view area.

Press “OK” button to activate the operating mode adjustment. When the activation is on, the white frame blinks around the graphical view.

In this menu; it is switching between operating modes with the “Left” and “Right” buttons.

Press “OK” button after selecting the operating mode.

➤ Manuel Operating Mode



X X X X → Shows the selected speed of the pump.

- Manuel Operating Mode is chosen from operating modes and press the “OK” button after selection.
- Press “Down” button to adjust desired manual operating point and then press “OK” button to select point.
- When the activation is on, the white frame blinks around the manual operating points.
- The desired speed is modified by “Up”-“Down” or “Left”-“Right” buttons with 50 rpm intervals.
- Press “OK” button after selection.

➤ Constant Pressure Operating Mode

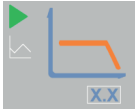

X X → Shows the selected head with 0.5 meter intervals.

- Constant Pressure Operating Mode is chosen from operating modes and press the “OK” button after selection.
- Press “Down” button to adjust desired constant pressure operating point and then press “OK” button to select point.
- When the activation is on, the white frame blinks around the constant pressure operating points.
- The desired head is modified by “Up”-“Down” or “Left”-“Right” buttons with 0.5m intervals. After 10m head, the interval scale rises to 1m.
- Press “OK” button after selection.

➤ Variable Pressure Operating Mode

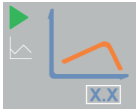

X X → Shows the selected head with 0.5 meter intervals.

- Variable Pressure Operating Mode is chosen from operating modes and press the “OK” button after selection.
- Press “Down” button to adjust desired variable pressure operating point and then press “OK” button to select point.
- When the activation is on, the white frame blinks around the variable pressure operating points.
- The desired head is modified by “Up”-“Down” or “Left”-“Right” buttons with 0.5m intervals. After 10m head, the interval scale rises to 1m.
- Press “OK” button after selection

7.2.3 Fault Messages

In this submenu, the errors and warnings which occur in the pump are shown. Refer to the Section 12 for fault handling.



“Fault” icon is appearing when warning/error occurred.

Errors/Warnings codes appear on the screen.

Press “OK” button upon on “Fault” icon and use direction keys to see other faults if more than one faults.

P X → “P” letter indicates that a warning was occurred.

“Fault LED” is on when there is error.

E/F X → “E” and “F” letters indicate that an error was occurred.

“Fault LED” blinks when there is warning. See the Figure 7.1 Number 2.

7.2 2-Digit Display

The two-digit display has five LEDs, three control buttons and one LED screen which occur from two digits. See Figure 7.2.

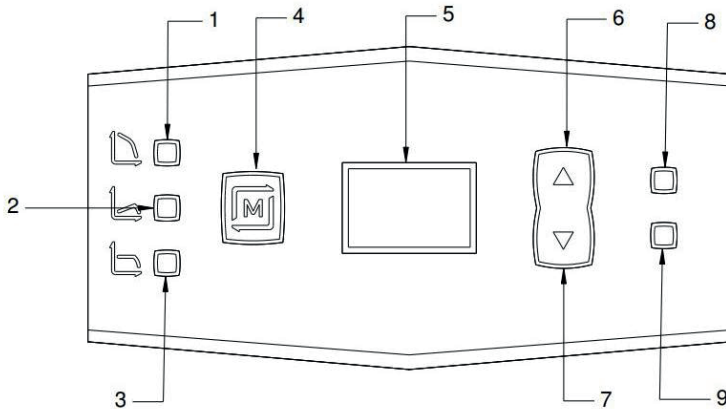

Figure 7.2: Control Display Layout of 2-Digit Display

The layout of the buttons and display:

1. Manuel Operating LED: It is on while the pump runs in manual operating mode.
2. Variable Pressure Operating LED: It is on while the pump runs in variable pressure operating mode.
3. Constant Pressure Operating LED: It is on while the pump runs in constant pressure operating mode.
4. "MENU" Button: To navigate through the menu.
5. Two row LED Display: Shows the operating modes and warning/error messages.
6. "Up" Button
7. "Down" Button
8. Remote Control LED (YELLOW): It blinks when getting a signal from the CCM module.
9. Fault LED (RED): It is on when there is a fault. It blinks when there is a warning.

The main menu is shown below:

X X → Shows the information about operating modes and warning/error messages.

In the main menu; it is switching between operating modes with the "MENU" button.

7.2.4 Operating Modes

➤ Manuel Operating Mode

C X → There are 3 types of manual operating mode which are C1, C2 and C3.

The pump sets in manual operating mode by pressing the "MENU" button.

"Manuel Operating LED" is on while the pump operates in manual operating mode.

The desired speed is modified by "Up" and "Down" buttons with 50 rpm intervals.

➤ **Constant Pressure Operating Mode**

X X → Shows the selected head with 0.5 meter intervals.

The pump sets in constant pressure operating mode by pressing the "MENU" button.

"Constant Pressure Operating LED" is on while the pump operates in constant pressure operating mode.

The desired head is modified by "Up" and "Down" buttons with 0.5m intervals. After 10m head, the interval scale rises to 1m.

➤ **Variable Pressure Operating Mode**

X X → Shows the selected head with 0.5 meter intervals.

The pump sets in variable pressure operating mode by pressing the "MENU" button.

"Variable Pressure Operating LED" is on while the pump operates in variable pressure operating mode.

The desired head is modified by "Up" and "Down" buttons with 0.5m intervals. After 10m head, the interval scale rises to 1m.

7.2.5 Fault Messages

In this submenu, the errors and warnings which occur in the pump are shown. Refer to the Section 12 for fault handling.

X X. → Shows the errors and warnings which occur in the pump

The symbol in front of the fault number shows the description of the fault.

P X. → "P" letter indicates that a warning was occurred.

"Fault LED" blinks till the dissolve the warning. See the Figure 7.2 Number 9.

E/F X. → "E" and "F" letters indicate that an error was occurred.

"Fault LED" is on when there is error. See the Figure 7.2 Number 9.

The decimal sign next to the Warning/Error number indicates that there is more than one error occurred. Use the "Up" and "Down" keys to switch between Warning/Error messages.

8. FIRST START-UP, CONTINUOUS OPERATION AND SHUTDOWN



Depending on the water temperature in the pipe system, any part of the pump is subject to high temperatures. In case of a contact to the non-plastic surfaces, there is a risk of burn and conflagration.

- Fill the system with water in minimum pressure and vent the air. For minimum pressure values see Table 5.3.
- Check the voltage values of the mains and compare with Table 5.2.
- Switch on the power to the pump.
- The pump starts to operate automatically when the power is on.
- At first start-up, the pump operates at maximum manual operating mode.
- At first start-up the display is shown below:

CAUTION

At first start-up, the pump display is in sleep mode. Press any of the buttons shown in Figure 7.1 and Figure 7.2 to wake up the display.

i. Graphical Display

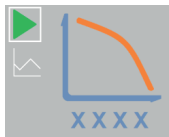

X X X X

→ Shows the current speed of the pump.

ii. 2-Digit Display

C 3

→ Shows the information about manual operating mode.

- To change the operating mode or speed / head, see Section 7.
- The display goes into the sleep mode after 5 minutes if the buttons are not pressed. Meanwhile, the pump continues to operate. The main menu is shown by pressing any button.

CAUTION

Non-display pump operate automatically when the power is on and continues to operate maximum speed if the additional module is not installed. Use additional accessories to adjust the operating modes. For detailed information about control modules see the ACM&CCM Additional Accessories Operating Instructions.

- In case of a power outage, the pump saves its last operating mode settings and resumes operating with those settings.
- To stop the pump;
 - i. For Graphical Display Press the "OK" button once on the main screen on the "Start/Stop" icon. See Section 7.1.1.

- ii. Switch off the power for 2-Digit Display and Non-Display types.
- iii. In the event of installed additional accessories, the pump can be started/stopped via additional accessories.

9. OPERATING MODES AND SELECTION CRITERIA

Optima circulation pumps save energy with its various types of operating mode choices, which they track the curves of system needs by the ECM technology.

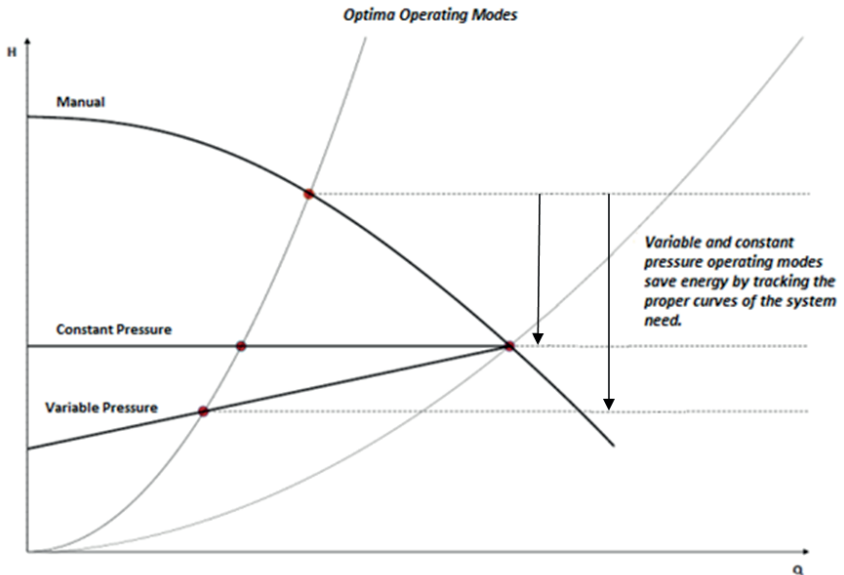

Figure 9.1: Optima Operating Modes

When the flow decreases (the operating point shifts to the left);

- the head increases in manual mode.
- the speed decreases and the head remains stable in constant pressure mode.
- the speed decreases and the head declines linearly until the half value of the selected head.

9.1 Manual Operating Mode

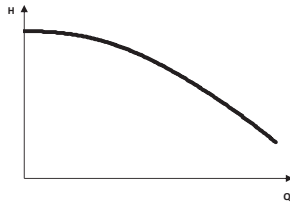

Figure 9.2: The curve of the Manual Mode

In this operating mode, the pump sets its speed fixed on the selected rpm. The speed is set by 50 rpm intervals.

9.2 Constant Pressure Operating Mode

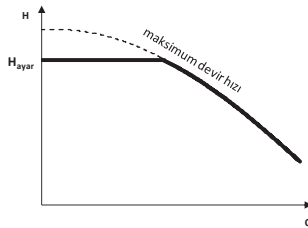

Figure 9.3: The curve of the Constant Pressure Mode

In this operating mode, the pump sets its speed to keep the selected head value (H_{set}) stable.

How to select the H_{set} value is given below:

- The operating point (the head and flow) of the system is determined.
- If the head is a multiple of 0.5, the exact value of the system is selected as H_{set} .
- If the head is not a multiple of 0.5, the closest value is selected as H_{set} .

In the following graph, the curves of the operating modes are drawn with 1 meter intervals. The head can be set by 0.5m intervals on the display.

According to the rule given above:

- A is set at **7.5m**
- B is set at **7.5m**
- C is set at **8m**
- D is set at **8m**

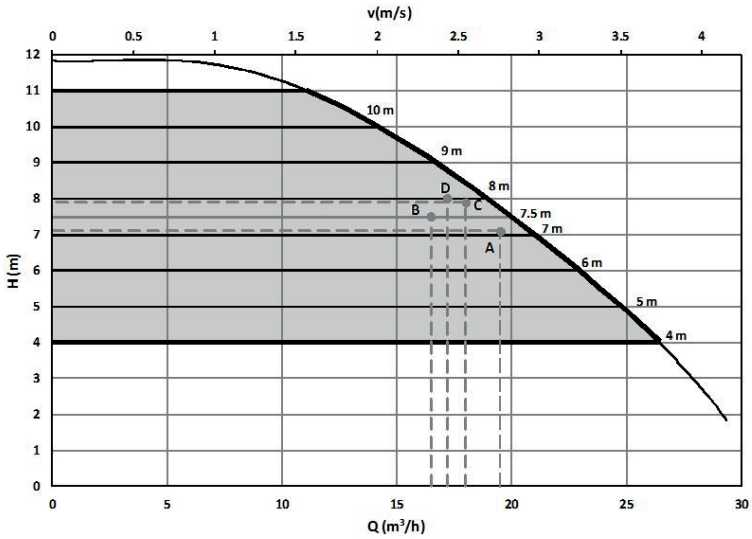

Figure 9.4: Example of the Constant Pressure Mode

9.3 Variable Pressure Operating Mode

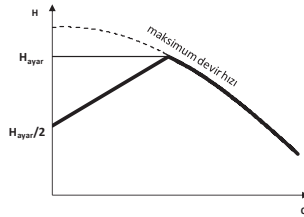

Figure 9.5: The curve of the Variable Pressure Mode

In this operating mode, the pump sets its speed by tracking a line between the selected head value (H_{set}) and half of it, depending on the flow changes in the system.

How to select the H_{set} value is given below:

- The operating point (the head and flow) of the system is determined.
- If the head is a multiple of 0.5, the exact value of the system is selected as H_{set} .
- If the head is not a multiple of 0.5, the closest value is selected as H_{set} .

In the following graph, the curves of the operating modes are drawn with 1 meter intervals. The head can be set by 0.5m intervals on the display.

According to the rule given above:

- A is set at **8.5m**
- B is set at **8.5m**
- C is set at **9m**
- D is set at **9m**

The figure below is given as an example:

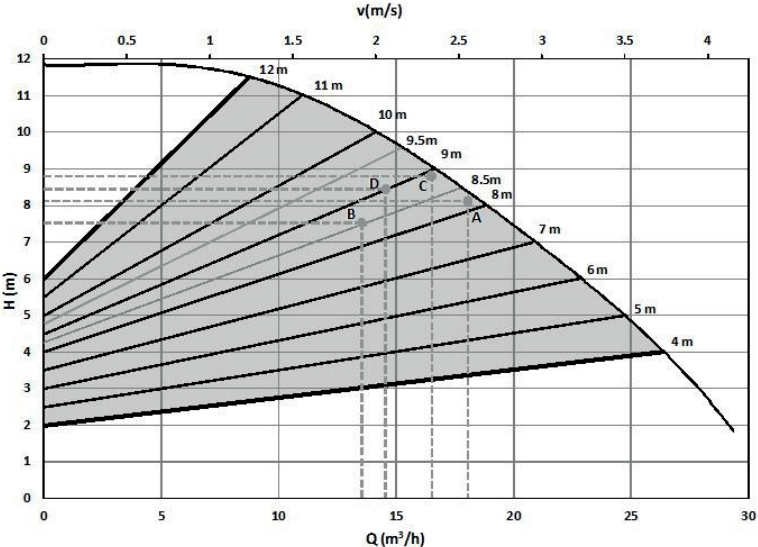

Figure 9.6: Example of the Variable Pressure Mode

9.4 Operating Mode Selection Criteria

The selection of the operating modes is based on the criteria which are given below:

	Manual Operating Mode	Variable Pressure Operating Mode	Constant Pressure Operating Mode
			
Two-Pipe Systems with Thermostatic Valves		<ul style="list-style-type: none"> * Delivery head loss > 4mSS * Very long distribution pipes * High head losses in the system * Differential pressure losses in the system * Strongly throttled pipe balancing valves 	<ul style="list-style-type: none"> * Delivery head loss < 2mSS * Natural circulation (low pressure loss, large pipe dimensions) * Low friction losses in the system
Single-Pipe Heating Systems	<ul style="list-style-type: none"> * Systems without flow exchanger component (thermostatic radiator valve, two-way cutter valve etc.) 		<ul style="list-style-type: none"> * Systems with thermostatic valves * Systems with thermostatic valves and strongly throttled pipe balancing valves
Floor Heating Systems	<ul style="list-style-type: none"> * Systems without flow exchanger component (thermostatic radiator valve, two-way cutter valve etc.) 	<ul style="list-style-type: none"> * Systems with thermostatic valves and high pressure losses * Strongly throttled pipe balancing valves 	<ul style="list-style-type: none"> * Systems with thermostatic valves and low pressure losses
Heating Systems with Condensing Boilers		<ul style="list-style-type: none"> * Secondary circuits * High pressure losses * Strongly throttled pipe balancing valves 	<ul style="list-style-type: none"> * Primary circuits * Low pressure losses * Natural circulation (low pressure losses, large pipe dimensions)
Flow and System Internal Resistance Non-Changing Systems	<ul style="list-style-type: none"> * DWH (Boiler) applications * Plate heat exchanger storage tank applications * Recirculation applications where low pressure loss and flow changes occur 		

Table 9.1: Operating Mode Selection Criteria

10. ADDITIONAL ACCESSORIES

The pump can operate integrated into the building management system with optional control modules. In this context, the Communication Control Module (CCM) and Analogue Control Module (ACM) are available for users.

The Communication Control Module (CCM) is a structure that provides communication between the control board of the pump and the building management system via serial communication protocols (RS-485) by using BACnet and Modbus protocols and allows changing or monitoring certain parameters on the pump. This module also features Multi pump with pre-installed scenarios.

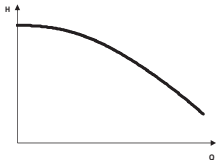
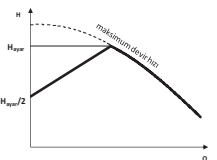
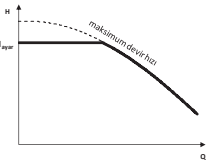
The Analogue Control Module (ACM) allows control of the actual speed of the pump via a PWM signal or a 0-10V control signal. It also has a relay-based structure on it that can immediately transmit faults of the pump to the building management system.

Refer to the ACM&CCM Additional Accessories Operating Instructions for detailed information about additional modules.

11. WARRANTY, MAINTENANCE AND SERVICE

Providing that the warnings, mounting and usage principals stated in this manual are applied, Alarko Optima Pumps are warranted to be free from defects in materials and manufacturing workmanship under normal use and service for a period of 2 (two) years. The malfunctions due to the imbalances in the electrical supply are outside of the scope of warranty.

Warranty document will be filled by Alarko Carrier Authorized Seller where the user purchased the product and one sheet of the document will be given to the user.

In warranty period, the warranty document must be saved and must be shown to the Alarko Carrier Authorized Service if necessary.

Minimum usage life specified by the Ministry of Science, Industry and Technology for those products is 10 (ten) years. According to the related rules, manufacturing and seller companies commit to serve and supply spare parts for the product in this warranty period.

Optima pumps do not need any special maintenance since the shaft and bearings rotate in water.

Please visit www.alarko-carrier.com.tr or call +90 212 444 0 128 if you encounter a problem or want to know the nearest customer service location.

12. FAULTS, CAUSES AND REMEDIES

DİKKAT

The troubleshooting must only be done by authorized service.



Before starting work, switch off the power supply.

Begin work 1 minute after switching off the power.

If any impeditive state occurs for the pumping operation, the pump automatically stops, gives a warning code.

In graphical display "Fault LED" is on when there is a fault or it blinks when there is a warning. See Figure 7.1

In 2-Digit display "Fault LED" is on when there is a fault or it blinks when there is a warning. See Figure 7.2

Non-Display models do not have a Fault LED. In the event of a fault, information about warning/error is sent to the building management system via additional control modules. For detailed information see the ACM&CCM Additional Accessories Operating Instructions.

It is possible to troubleshoot the problem with the fault codes. See Table 12.1 and Table 12.2

DİKKAT

Do not interfere in the buttons or display if any error occurs.

1. When the warning occurs, the warning code appears on the display; the pump does not stop and continues to operate.
2. When the warning is disappeared, the warning code on the display is automatically deleted.
3. When the error occurs, the error code appears on the display and the pump stop to operate.
4. The pump stands by for 30 seconds after an error occurs.
5. If the cause of the error disappears after 30 seconds, the pump resumes operating.
6. If the cause proceeds, the error is given once more.
7. If a fault cannot be repaired, contact a customer service.

DİKKAT

Obtain the spare parts from a customer service.

Using of non-original spare parts cause a breach of warranty

Warning Code	Cause	Remedy
p0	Input voltage is above 245V.	Ensure that the input voltage is within specified limits.
p1	Input voltage is below 207V.	Ensure that the input voltage is within specified limits.
p3	The motor speed exceeds the setpoint speed.	If the system has multiple pumps, make sure the pumps all operate at the same speed.
p4	<p>No connection to master pump (Master/Slave mode):</p> <ul style="list-style-type: none"> - A control card with CCM configured as slave pump has no connection with the master pump. - Invalid Multi-pump configuration of master or slave pump(s). 	<p>Verify the connection cable between the slave pump and the master pump.</p> <p>Verify that the master pump is powered on.</p> <p>Ensure that the network size (number of pumps) is set correctly in the master pump.</p> <p>Ensure that each pump in the network has a unique ID set and that each ID is set to a value less than the network size.</p>
p5	<p>No connection to slave pump:</p> <ul style="list-style-type: none"> - A control card with CCM configured as master pump has lost connection to at least one slave pump. - Invalid Multi-pump configuration of master or slave pump(s) 	<p>Verify the connection cable between the master pump and the slave pump(s).</p> <p>Verify that all slave pump(s) are powered on.</p> <p>Ensure that the network size (number of pumps) is set correctly in the master pump.</p> <p>Ensure that each pump in the network has a unique ID set and that each ID is set to a value less than the network size.</p>
p6	<p>Incompatible Slave Pump:</p> <p>At least one slave pump in the network has an incompatible firmware version.</p> <p>At least one slave pump in the network is a different pump type than the master pump.</p>	<p>Ensure that all pumps in the network are of the same pump type.</p> <p>To ensure that all control cards and CCM modules in the Multi-Pump network have compatible firmware versions (and update if needed), call service support.</p>
p7	<p>High Card Temperature:</p> <ul style="list-style-type: none"> - The temperature of the control card exceeds the warning limit. 	<p>Verify that ambient temperature is within allowed operating range. Try to lower it.</p>

Table 12.1: Warning Codes

Error Code	Cause	Remedy
E0	<p>Motor Temperature: Temperature of motor windings is either too high or too low.</p>	<p>Check that water temperature is within allowed range.</p> <p>Wait for the motor to cool down.</p> <p>To verify that the motor temperature sensors are not damaged (shorted/open), call service support.</p>
E1	<p>Card Temperature: Temperature of control card electronics is either too high or too low.</p> <p>Faulty connection between motor temperature sensor and control card.</p>	<p>Ensure that the control card is properly mounted on the motor, and properly connected to the motor.</p> <p>Verify that ambient temperature is within allowed operating range. Try to lower it.</p> <p>Wait for control card to cool down.</p> <p>To verify that the motor temperature sensors are not damaged (shorted/open), call service support.</p>
E2	<p>Motor Over-Loaded: - Current through motor is too high.</p>	<p>Ensure that the motor is properly connected to the control card.</p> <p>Ensure that the rotor can run freely without obstruction.</p> <p>Wait for control card to restart the pump.</p>
E3	<p>Loss of Rotor Lock: - Software lost rotor position lock.</p>	<p>Wait for control card to restart the pump.</p> <p>Ensure that the rotor can run freely without obstruction.</p>
E4	<p>Reverse Flow: - Motor is pushed in the wrong direction.</p>	<p>Install non-return valve to ensure water can only flow in the correct direction through the pump.</p>
E7	<p>Rotor Blocked: - The motor was unable to start due to blockage (after attempting unblocking routine)</p>	<p>Wait for control card to restart the pump.</p> <p>Remove any obstructions from the rotor.</p>
E9	<p>Multiple Reasons: - A card defect was detected during power-up.</p>	<p>Ensure that the motor is properly connected to the control card.</p> <p>-Power-toggle the control card.</p>

	<ul style="list-style-type: none"> - Faulty connection between motor temperature sensor and control card. - Faulty connection between motor windings and control card. - Corrupt firmware. - Control card firmware incompatible with hardware. 	<ul style="list-style-type: none"> -To verify that the motor temperature sensors or motor windings are not damaged (shorted/open), and to verify the correct firmware on the card, call service support. -After repeated failure, replace control card.
F0	Input voltage is above 253V.	Ensure that the input voltage is within specified limits.
F1	Input voltage is below 180V.	Ensure that the input voltage is within specified limits.
F4	<p>Motor Sensor Connection:</p> <ul style="list-style-type: none"> - Faulty connection between motor temperature sensor and control card 	<ul style="list-style-type: none"> - Ensure that the motor is properly connected to the control card. - To verify that the motor temperature sensors are not damaged (shorted/ open), call service support.
F5	<p>No connection to master pump (Main/Standby or Pump Cycling mode)</p> <ul style="list-style-type: none"> - A control card with CCM configured as slave pump has no connection with the master pump - Invalid Multi-pump configuration of master or slave pump(s) 	<p>Verify the connection cable between the slave pump and the master pump</p> <ul style="list-style-type: none"> - Verify that the master pump is powered on - Ensure that the network size (number of pumps) is set correctly in the master pump. - Ensure that each pump in the network has a unique ID set and that each ID is set to a value less than the network size.
F6	<p>[CCM] Multiple master pumps:</p> <ul style="list-style-type: none"> - The master/slave pump network contains multiple pumps that are configured as master pump 	Ensure that only one pump in the network is configured as master pump. The other pumps must be set as slave pumps.

Table 12.2: Error Codes

The fault flowchart of the pump is given below:

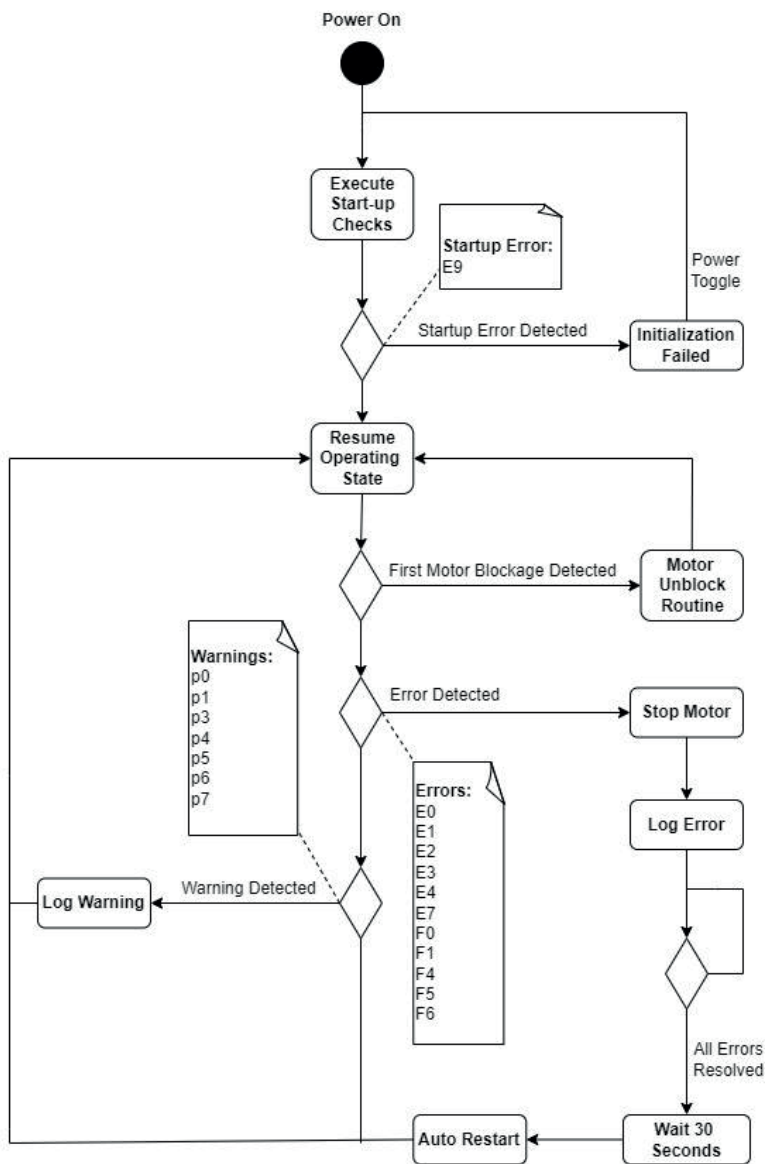

Figure 11.3: Fault Flowchart

13. DISMANTLING



Dismantling of the pump must be carried out by qualified personnel and in accordance with the instructions on this manual and also with applicable regulations.



Before dismantling, switch off the power supply. All dismantling process must be done while the power is OFF.



Wait until the display is completely turned off.



If the temperature of the system water is high, wait until the water is cooled off or drain the water cautiously.



Take the warnings and instructions in Section Error! Reference source not found. and Error! Reference source not found. into consideration while dismantling.



In the pump dismantling process, in cases where the motor body is separated from the pump body, the O-ring between the motor body and the pump body should be replaced with a new one. There is one spare O-ring in the packaging box.



Dismantling of the rotor from the pump motor must only be done by technical staff, since the rotor has very powerful magnets mounted on it. Otherwise, it may cause injuries.



Pump rotor has a strong magnetic field. Therefore, after dismantling from the pump motor, below effects can occur:

- Usage failure in electronic devices,
- Strong attraction of metals and magnetic materials,
- Risk of injury due to the effects above.

- Switch off the power to the pump.
- Wait 1 minute.
- Disconnect the power supply cable.
- Close the valves on the inlet and outlet side to isolate the pump from water flow.
- Remove the bolts, nuts, washers and then the pump housing.

14. DISPOSAL

For the disposal of the pump, authorized technical services or related recycling facilities can be used. Warnings and cautions in Section 13 must be taken into consideration while dismantling the pump. Disposal of the pump or pump parts must be performed considering the environmental impact and in accordance with the related regulations

15. APPENDIX

15.1 Dimensions

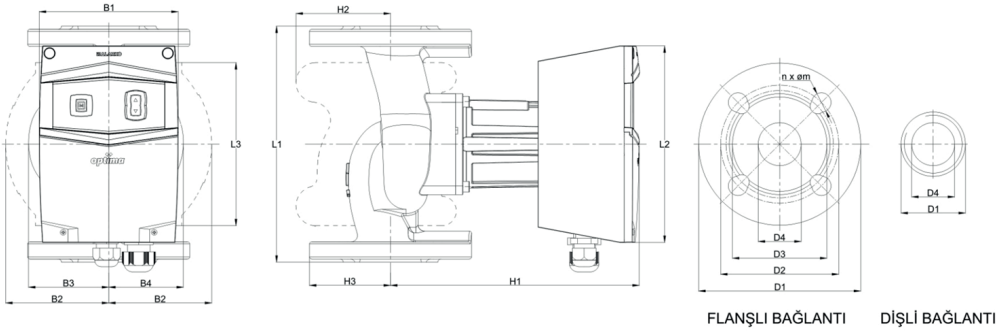

FLANŞLI BAĞLANTI

DIŞLI BAĞLANTI

PUMP TYPE	D1 (mm)	D2 (mm)		D3 (mm)	D4 (mm)	n x Øm(mm)		B1 (mm)	B2 (mm)	B3 (mm)	B4 (mm)	L1 (mm)	L2 (mm)	L3 (mm)	H1 (mm)	H2 (mm)	H3 (mm)	Weight (kg)
		PN6	PN10			PN6	PN10											
OPTIMA 5/8	166.0	110.0	125.0	102.0	50.0	4x14	4x18	129.5	96.0	69.7	57.5	240.0	183.0	152.0	232.0	88.0	83.0	12
OPTIMA 4/10	151.0	100.0	110.0	88.0	40.0	4x14	4x18	129.5	81.0	65.3	55.7	220.0	183.0	152.0	232.6	77.9	75.5	10.5
OPTIMA 4/8	151.0	100.0	110.0	88.0	40.0	4x14	4x18	129.5	96.0	69.7	57.5	220.0	183.0	152.0	232.0	88.0	75.5	12
OPTIMA 4/4	151.0	100.0	110.0	88.0	40.0	4x14	4x18	129.5	96.0	69.7	57.5	220.0	183.0	152.0	232.3	88.0	75.5	12
OPTIMA 3/12-180	G2"	-	-	-	30.0	-	-	129.5	82.5	65.3	55.7	180.0	183.0	152.0	233.0	77.5	29.8	6.5
OPTIMA 3/10-180	G2"	-	-	-	30.0	-	-	129.5	82.5	65.3	55.7	180.0	183.0	152.0	232.6	77.5	29.8	6.2
OPTIMA 3/7-180	G2"	-	-	-	30.0	-	-	129.5	82.5	65.3	55.7	180.0	183.0	152.0	232.6	77.5	29.8	6.2
OPTIMA 2/10-180	G1 1/2"	-	-	-	25.0	-	-	129.5	82.5	65.3	55.7	180.0	183.0	152.0	232.6	77.5	23.9	6.2

15.2 General Selection Chart and Performance Curves

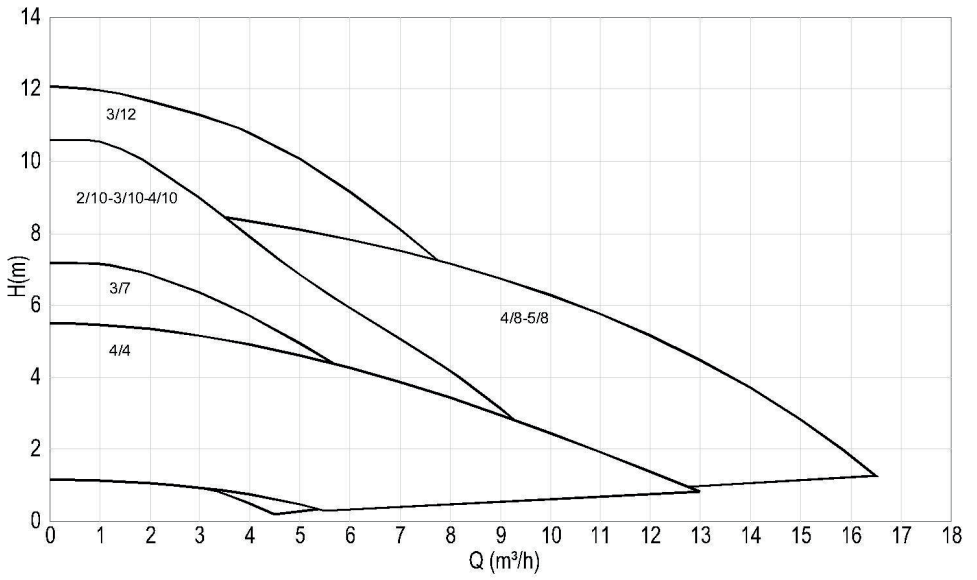

➤ OPTÍMA 5/8

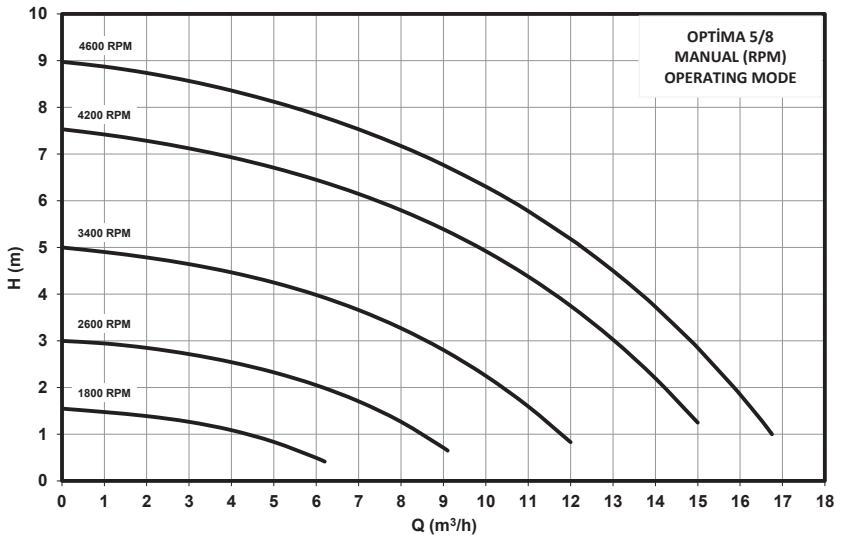
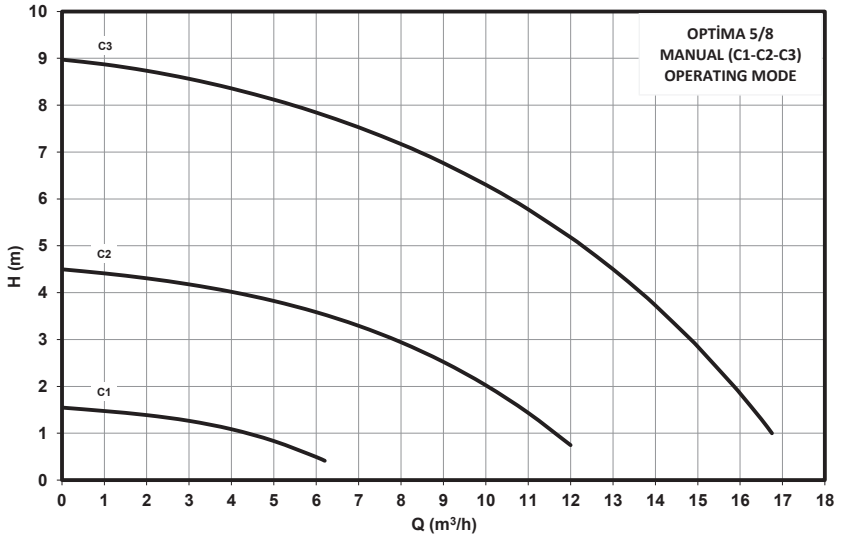

➤ OPTÍMA 5/8

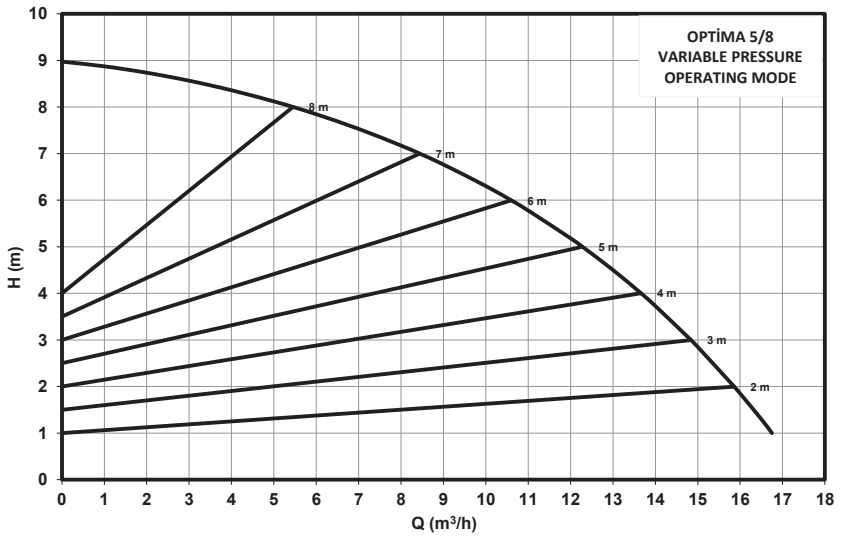
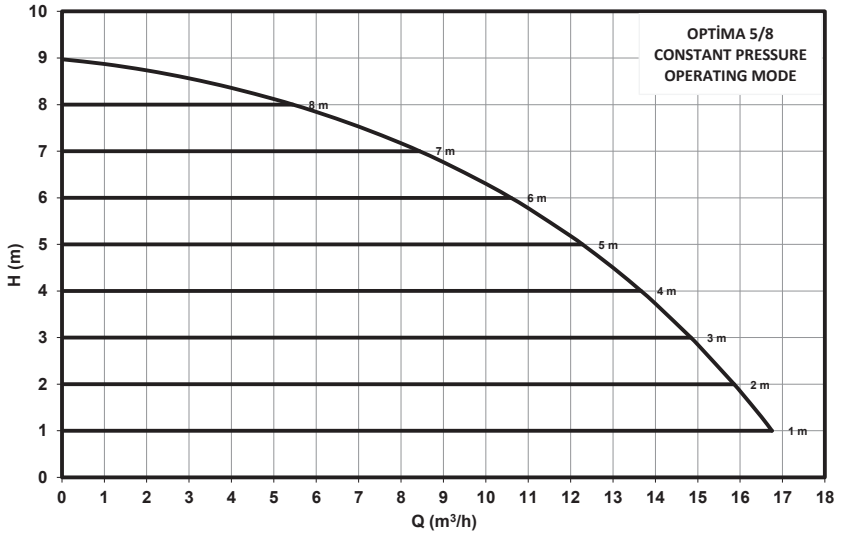

➤ OPTIMA 4/10

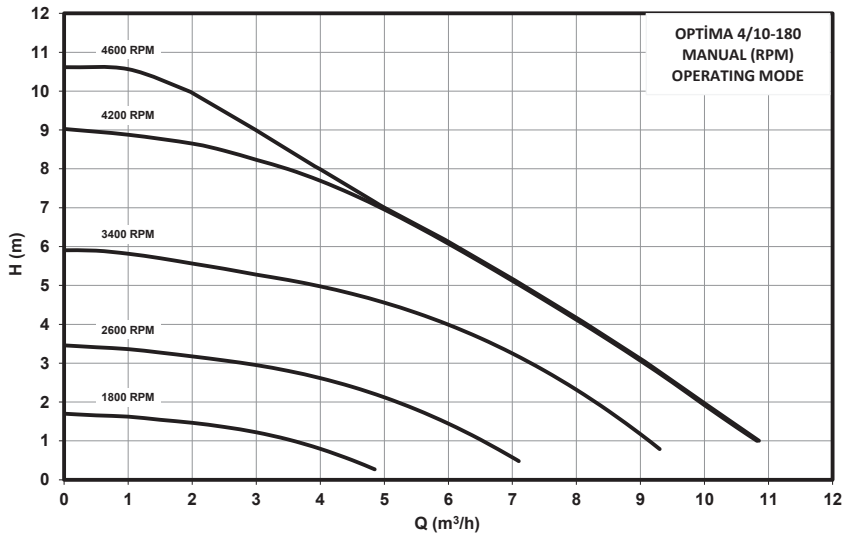
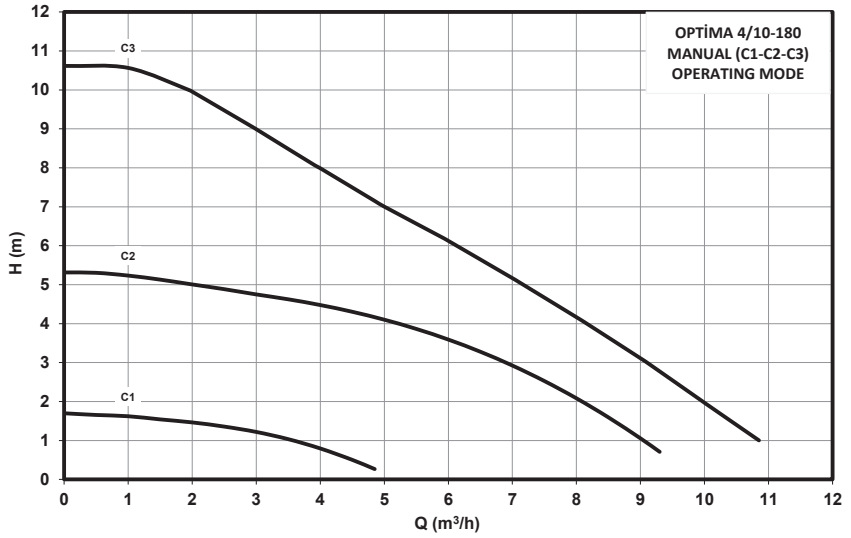

➤ OPTIMA 4/10

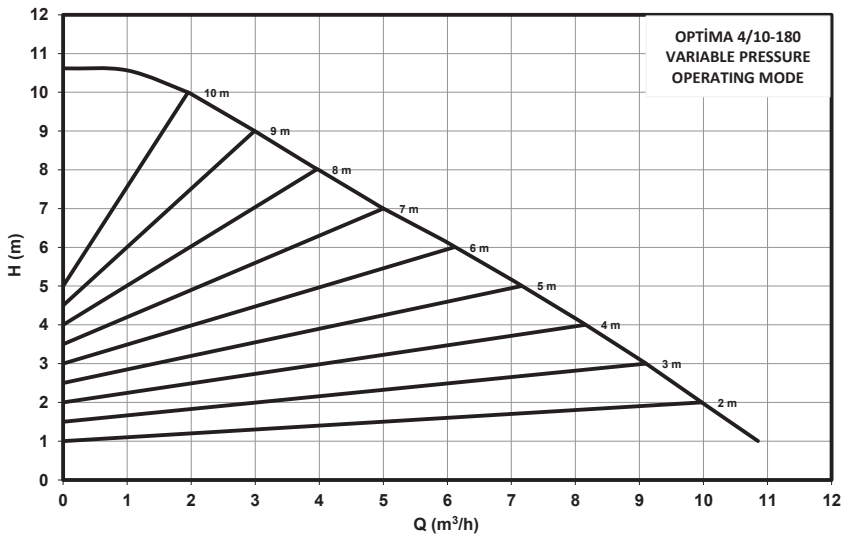
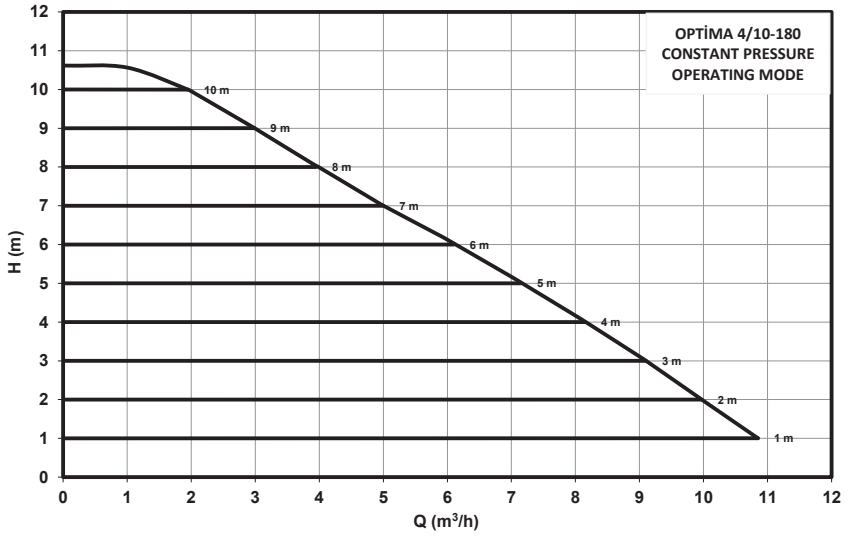

➤ **OPTIMA 4/8**

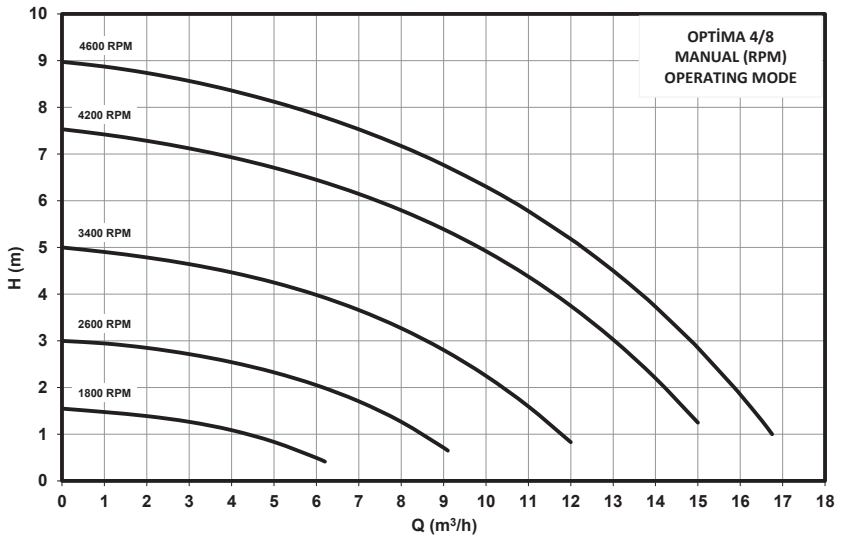
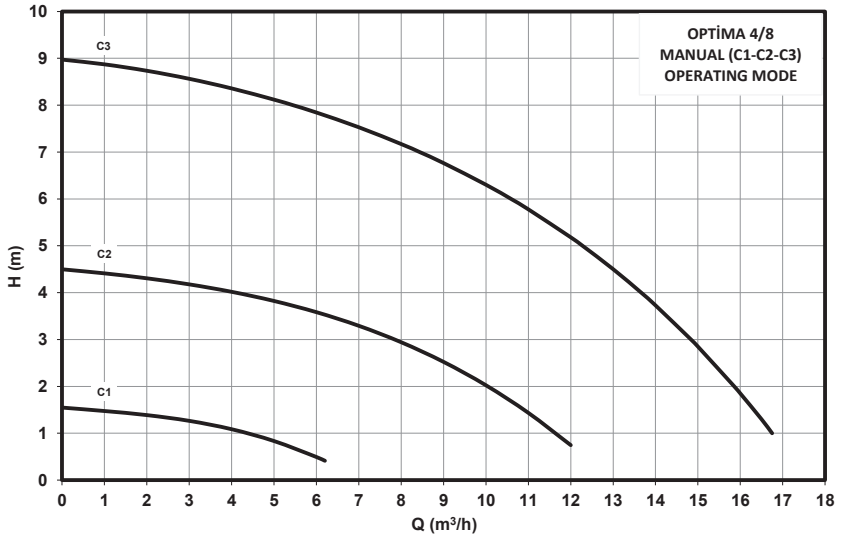

➤ OPTIMA 4/8

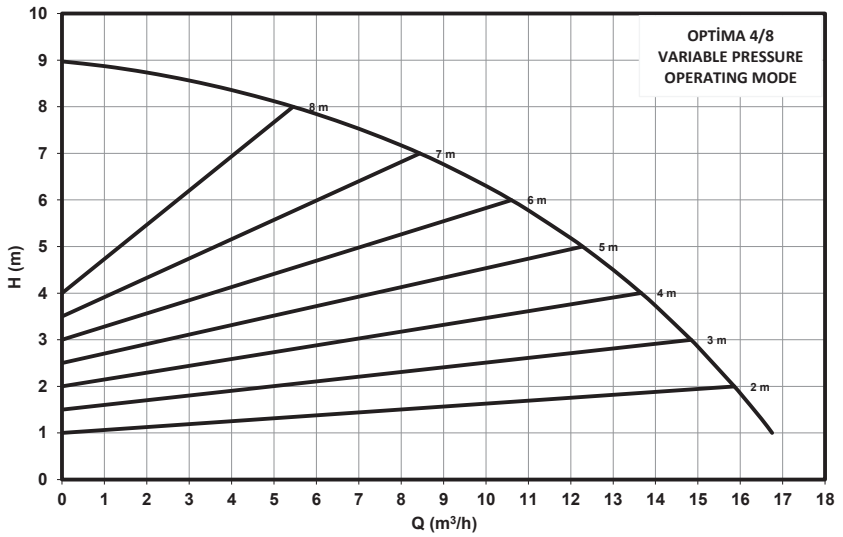
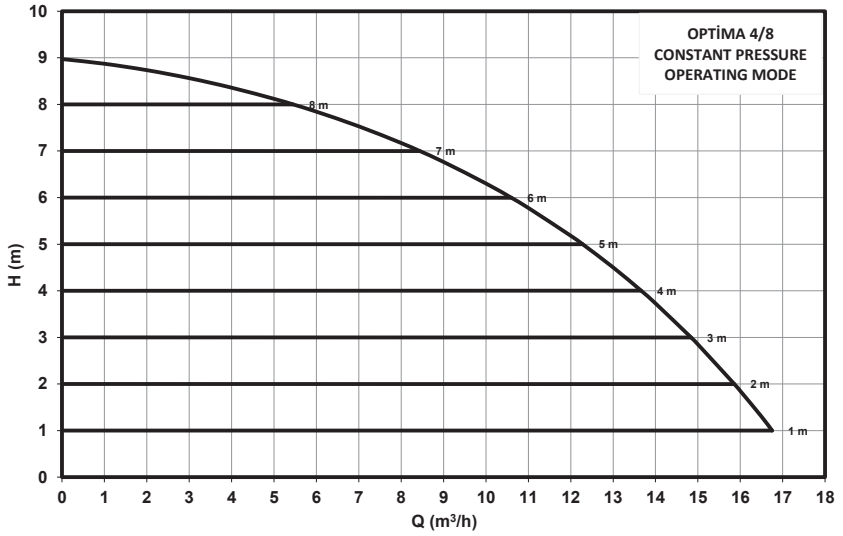

OPTIMA 4/4

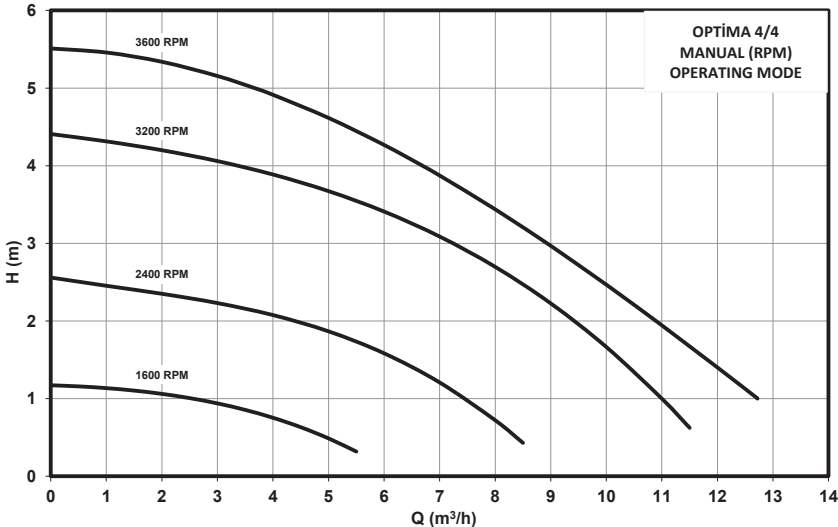
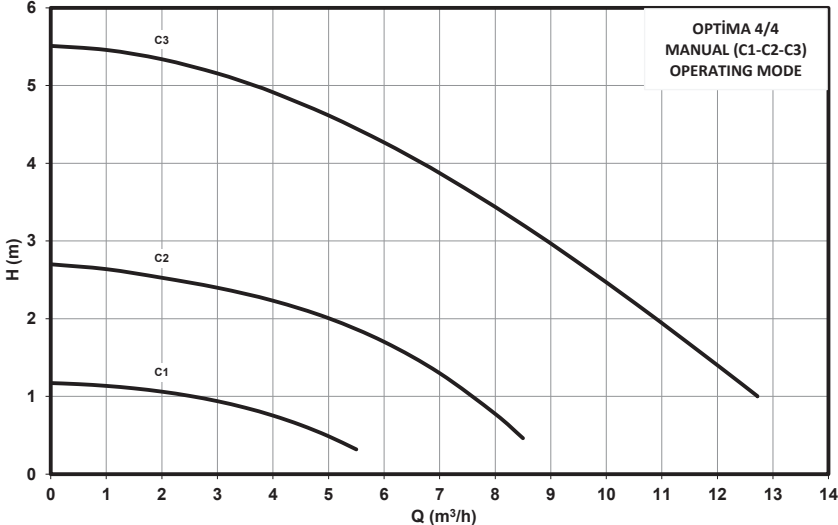

➤ OPTIMA 4/4

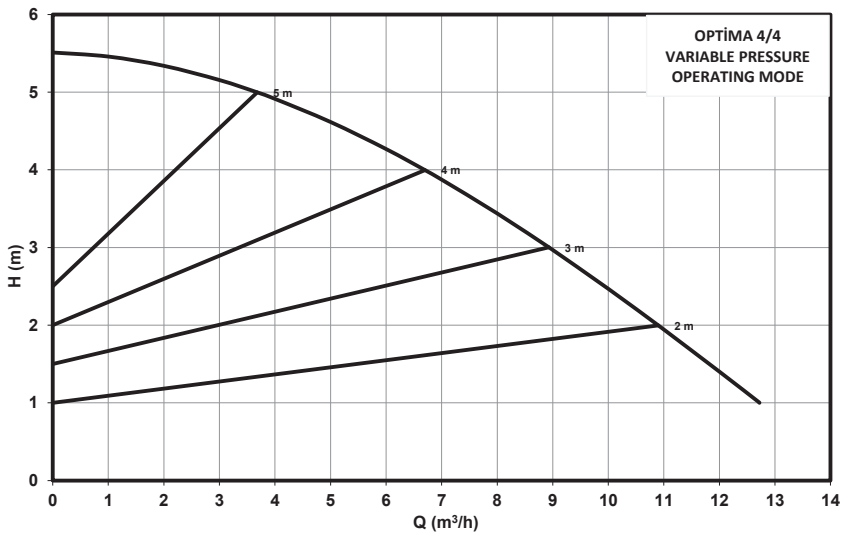
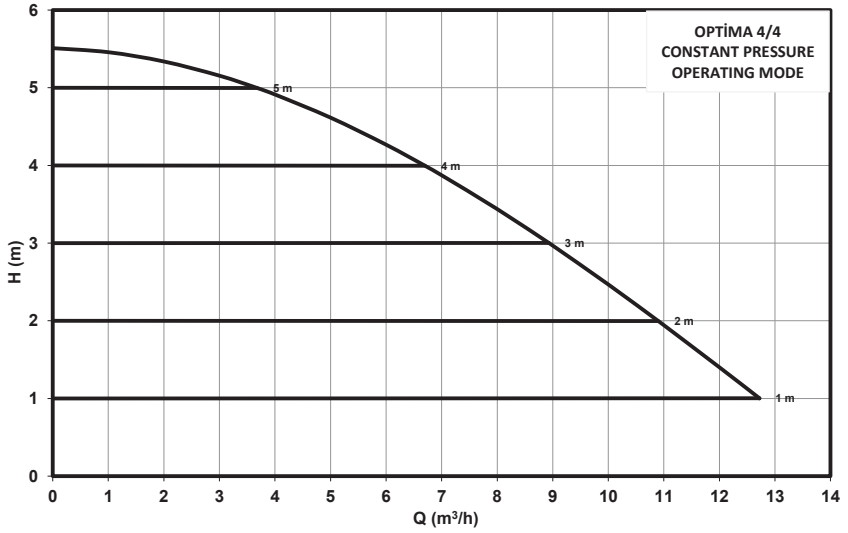

➤ OPTIMA 3/12-180

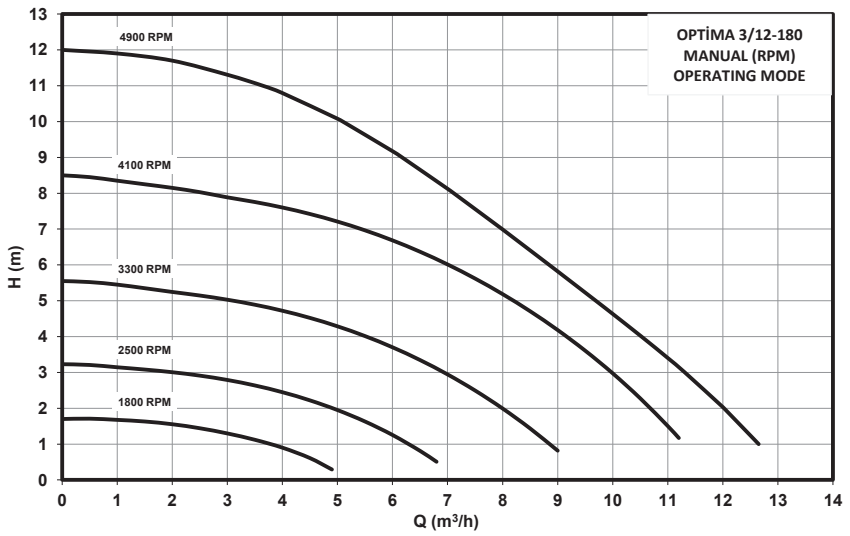
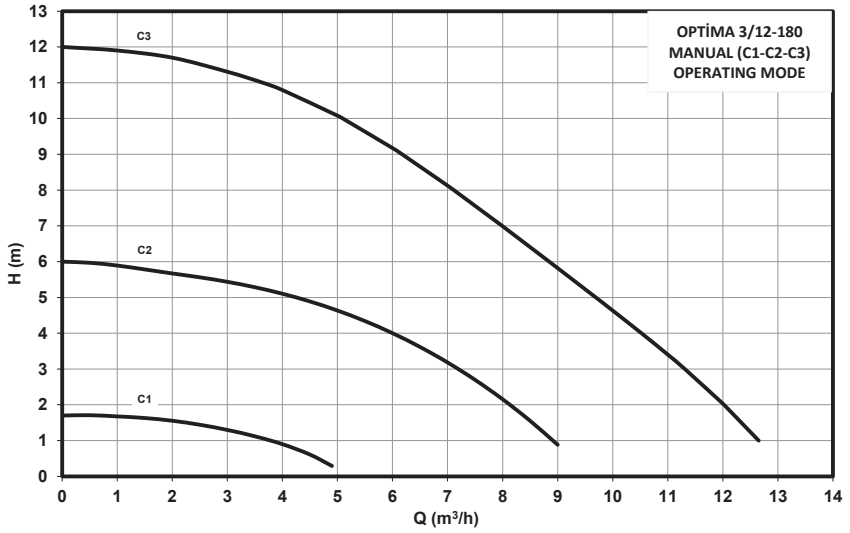

➤ OPTIMA 3/12-180

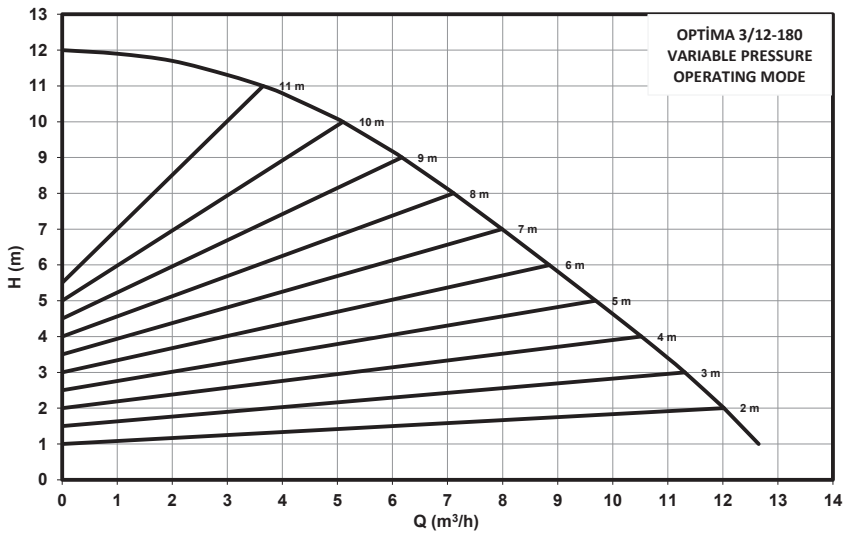
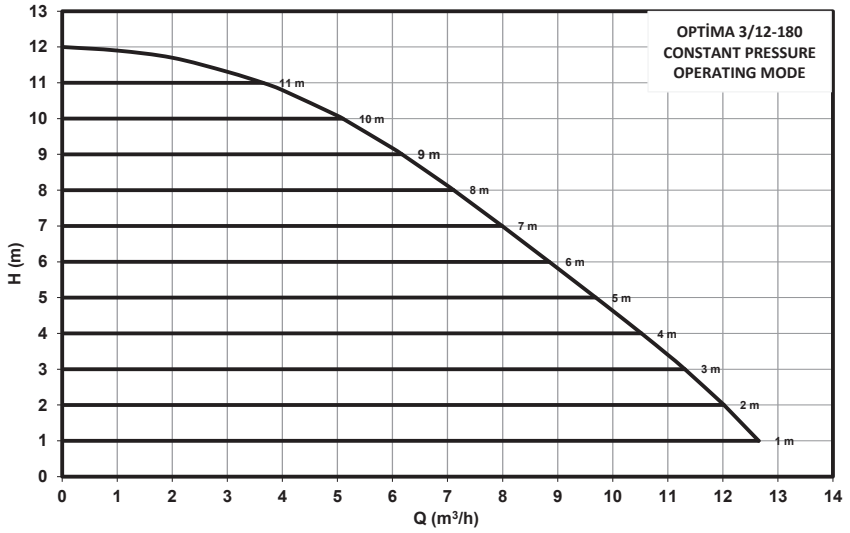

➤ OPTIMA 3/10-180

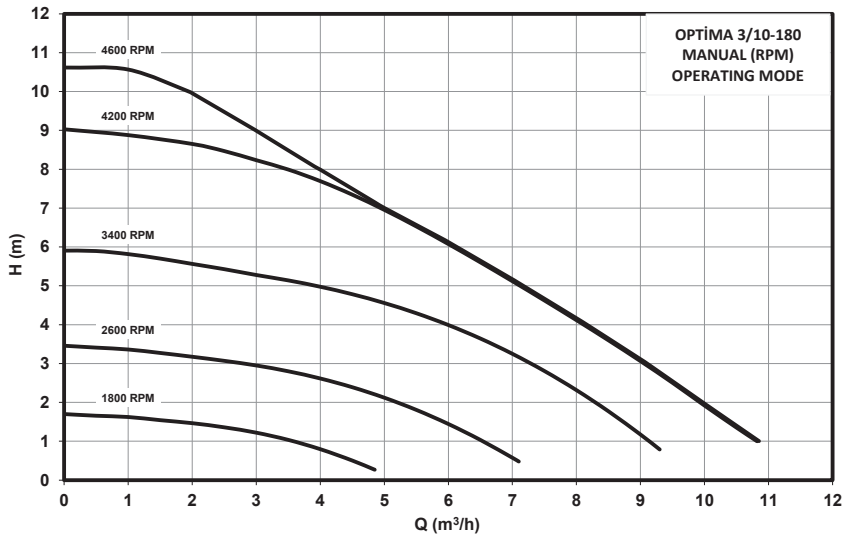
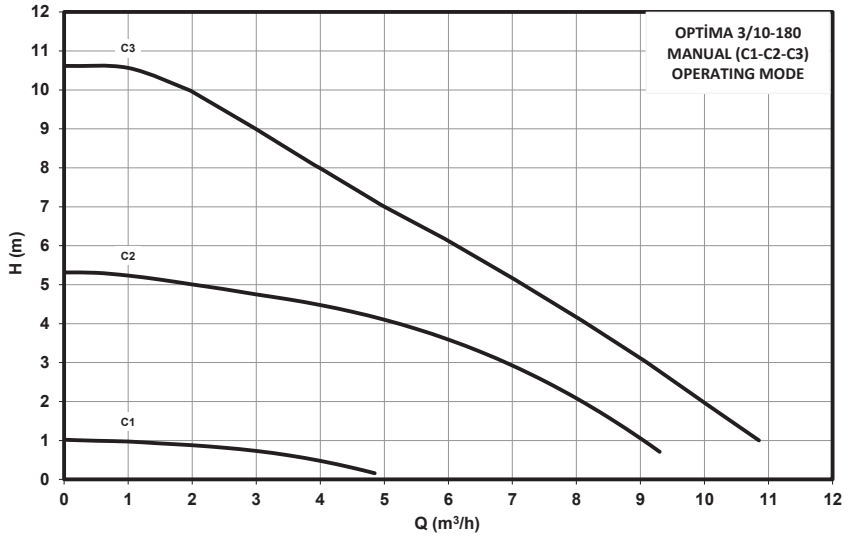

➤ OPTIMA 3/10-180

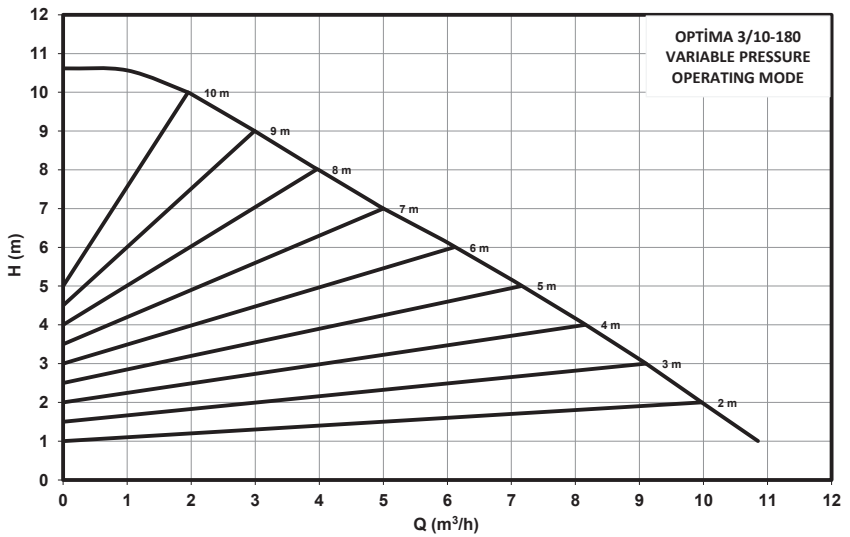
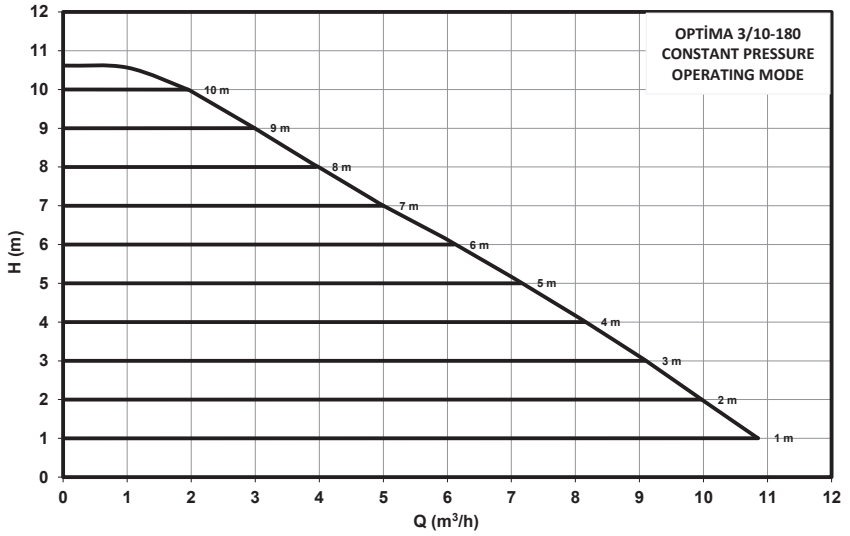

➤ OPTIMA 3/7-180

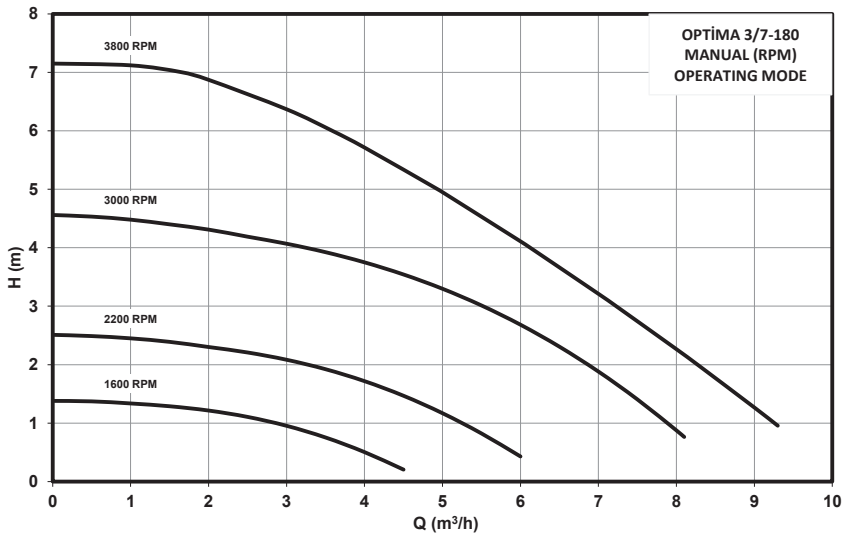
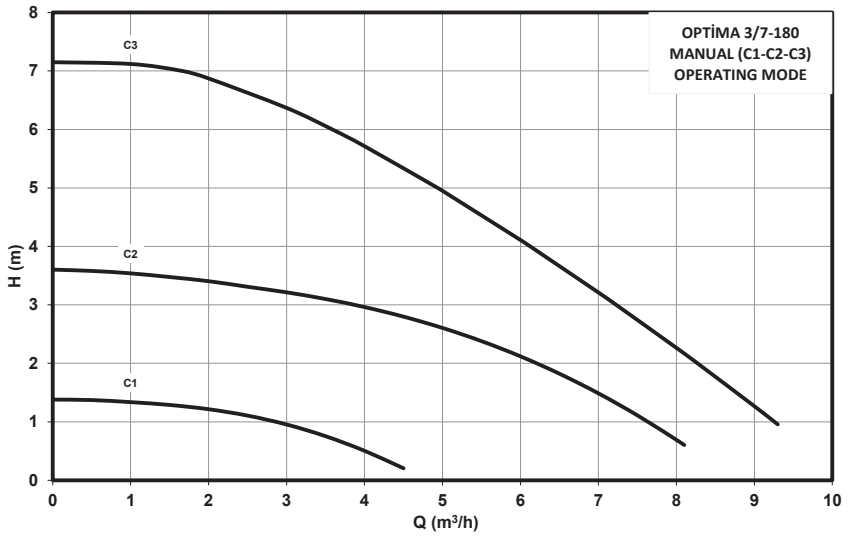

➤ OPTIMA 3/7-180

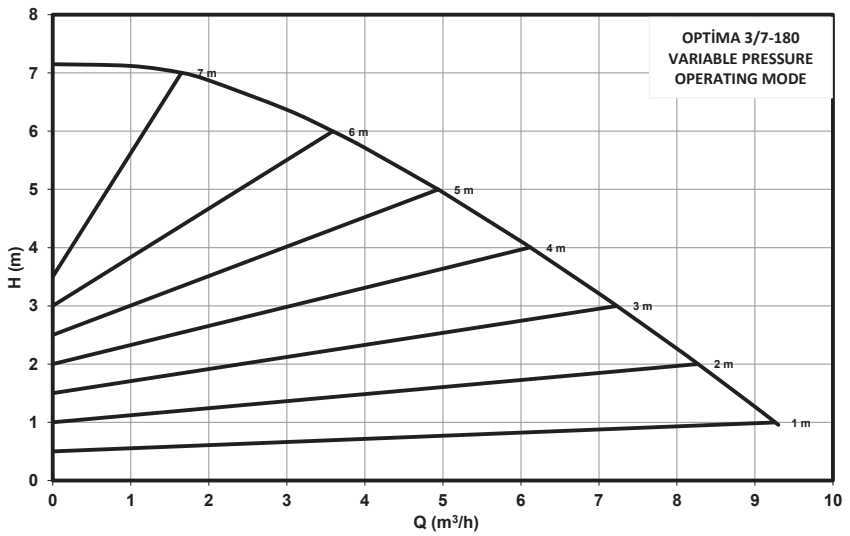
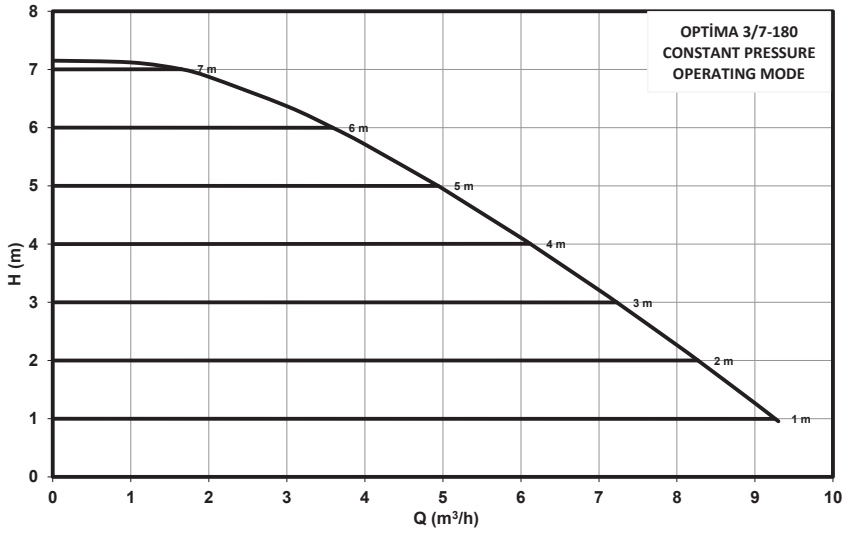

➤ OPTIMA 2/10-180

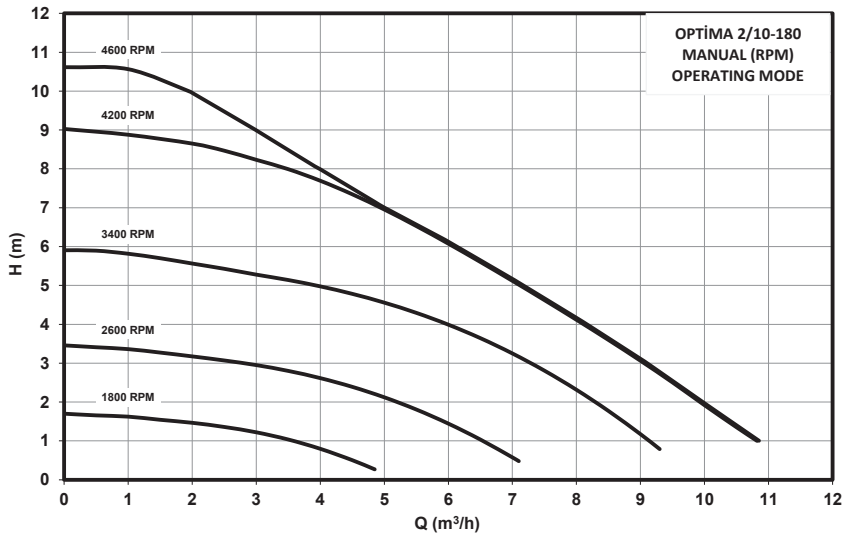
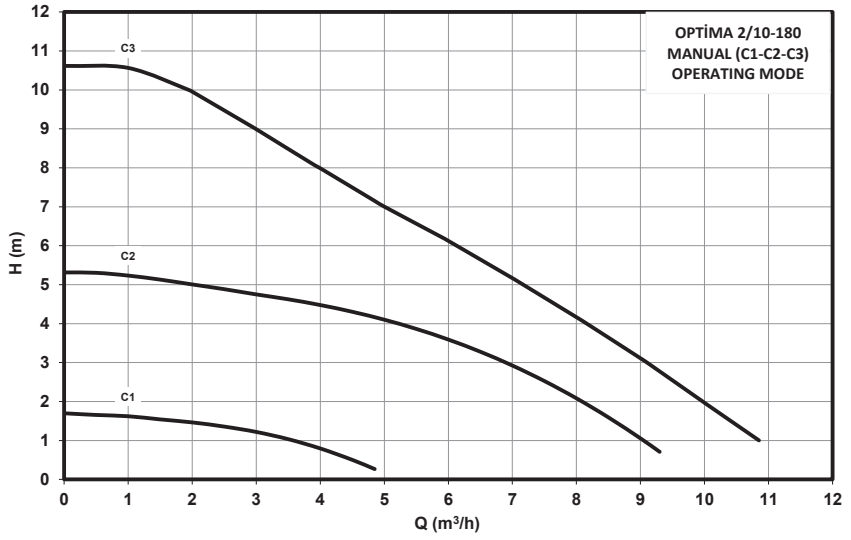

➤ OPTIMA 2/10-180

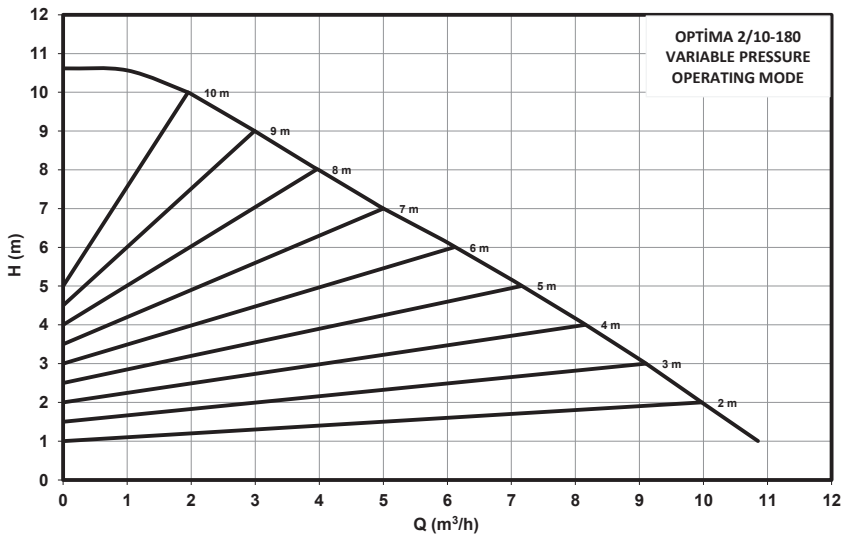
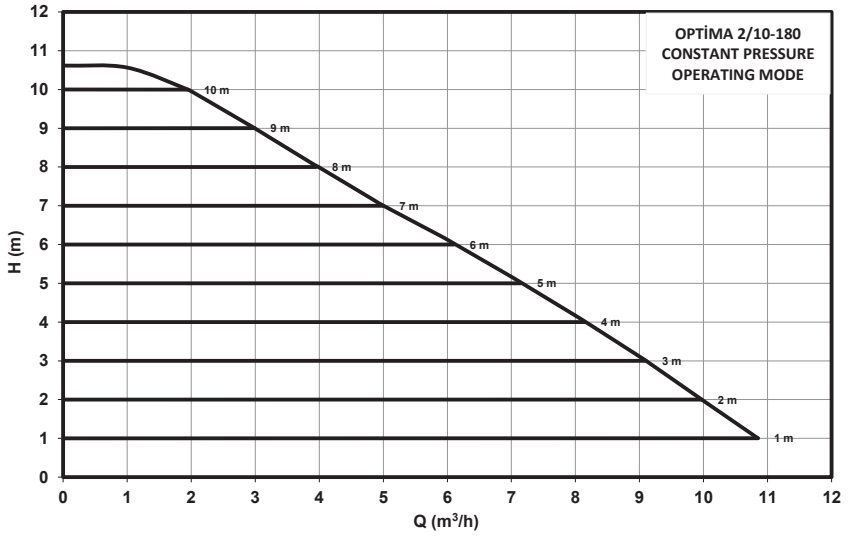

ALARKO



ALARKO CARRIER
SANAYİ VE TİCARET A.Ş.

İSTANBUL : GOSB - Gebze Org. San. Bölgesi, Ş. Bilgişu Cad. 41480 Gebze-KOCAELİ
Tel: (0262) 648 60 00 - Fax: (0262) 648 60 08
ANKARA : Sedat Simavi Sok. No: 48, 06550 Çankaya - ANKARA
Tel: (0312) 409 52 00 - Fax: (0312) 440 79 30
İZMİR : Şehit Fethibey Cad. No:55, Kat:13, 35210 Pasaport - İZMİR
Tel: (0232) 483 25 60 - Fax: (0232) 441 55 13
ADANA : Ziyapaşa Bulvarı Çelik Ap. No : 25/5-6, 01130 ADANA
Tel: (0322) 457 62 23 - Fax: (0322) 453 05 84
ANTALYA : Mehmetçik Mahallesi Aspendos Bulvarı No: 79/5 - ANTALYA
Tel: (0242) 322 00 29 - Fax: (0242) 322 87 66
MDH : 444 0 128

web: www.alarko-carrier.com.tr
e-pošta: info@alarko-carrier.com.tr