



Submersible Pump AL 6"-8" KPS Series



TECHNOLOGY GIVING LIFE TO WATER





Alarko submersible pumps are

**UNIQUE INDIVIDUAL
and UNINTERRUPTED
WATER SOURCE**

in potable water status by

- Evertime being ready to use,
- With no trouble
- And with short reimbursement term.



Alarko submersible pumps are

MULTIFUNCTIONAL

because of usable for from detached houses to skyscrapers and because of obtained advantage using it as a water stocking hydrophore.



Alarko submersible pumps are

**PROPER
INVESTMENT**

in providing using water and process water in industrial facilities and administrations because of

- High efficiency
- And long life period.

ALARKO, ALWAYS NUMBER ONE IN SUBMERSIBLE PUMPS





Alarko submersible pumps are

RELIABLE FRIENDS

of garden lovers and farmers on horticulture, agriculture and from little house garden to agricultural land as thousands acres.



Alarko submersible pump is a

UNIQUE RELIABLE WATER

SOURCE for touristic facilities, which especially need more water in tourism term.

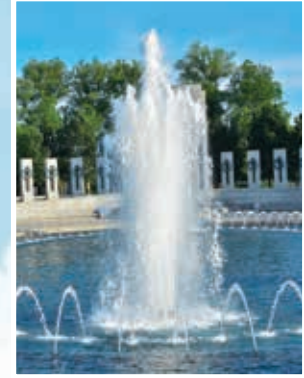

Alarko submersible pumps are

PREEMINENT

because of

- High technology
- Economy
- Continual and quality service
- Quick procurement of spare part.



ADVANTAGES

- It does not have to be protected from open air conditions because motor works in the well water.
- No limitation for the depth of immersion. It can be come down to deep as total head.
- Any special tube or tool is not required.
- There is not fan adjustment problem.
- Shaft cutting or oil lack is not experienced.
- Mounting is easily and there is not any axle alignment problem.
- It is silent.
- It is not effected well inclines as pump with perpendicular shaft.
- Capability of using drill pipe of 6 5/8" instead of 8" for 70 m³/h flowrate of up to 50 Hp motor power, 8 5/8" drill pipe instead of 10 3/4" for 118 m³/h flowrate.

APPLICATION DATAS

- Three-phase squirrel cage asynchronous water lubricated motors with powers between 10-180 HP.
- Special isolated stator which uses coil wire suitable to work under water.
- Horizontal bearing assembly that carries axial load and water lubricated radial bearing.
- Flat motor exit cable, cut in standard length, designed specially for working under water.
- Should give direct way up until 20 HP, and star-delta between 25-180 HP.
- Optional design in AL 6"-8" motors suitable for Operation with different frequency and voltage values with soft starter.
- Automatic pump activation-deactivation control according to the well water level through water level relay.
- Protecting the motor against two-phase operation instabilities with phase control relay.
- Protection of the pump from short circuit through fuses.

DESIGN

All Alarko 6" and 8" KPS pumps are made entirely of stainless steel AISI 304 (DIN W.-Nr.1.4301). For particularly aggressive liquids pumps are available in extra high grade stainless steel AISI 316 (DIN W.-Nr.1.4401). For handling slightly contaminated water such as oil containing water we can offer all rubber parts made of Viter® as an option.

The octagonal rubber bearing and build in sand protection shields are designed to ensure that sand is removed from the pump and meter by the water that is being pumped.

APPLICATION LIMITS

- Five series of 6", 8" as per pump's nominal diameter.
- Total 7 models and 55 types between 10 and 180 HP

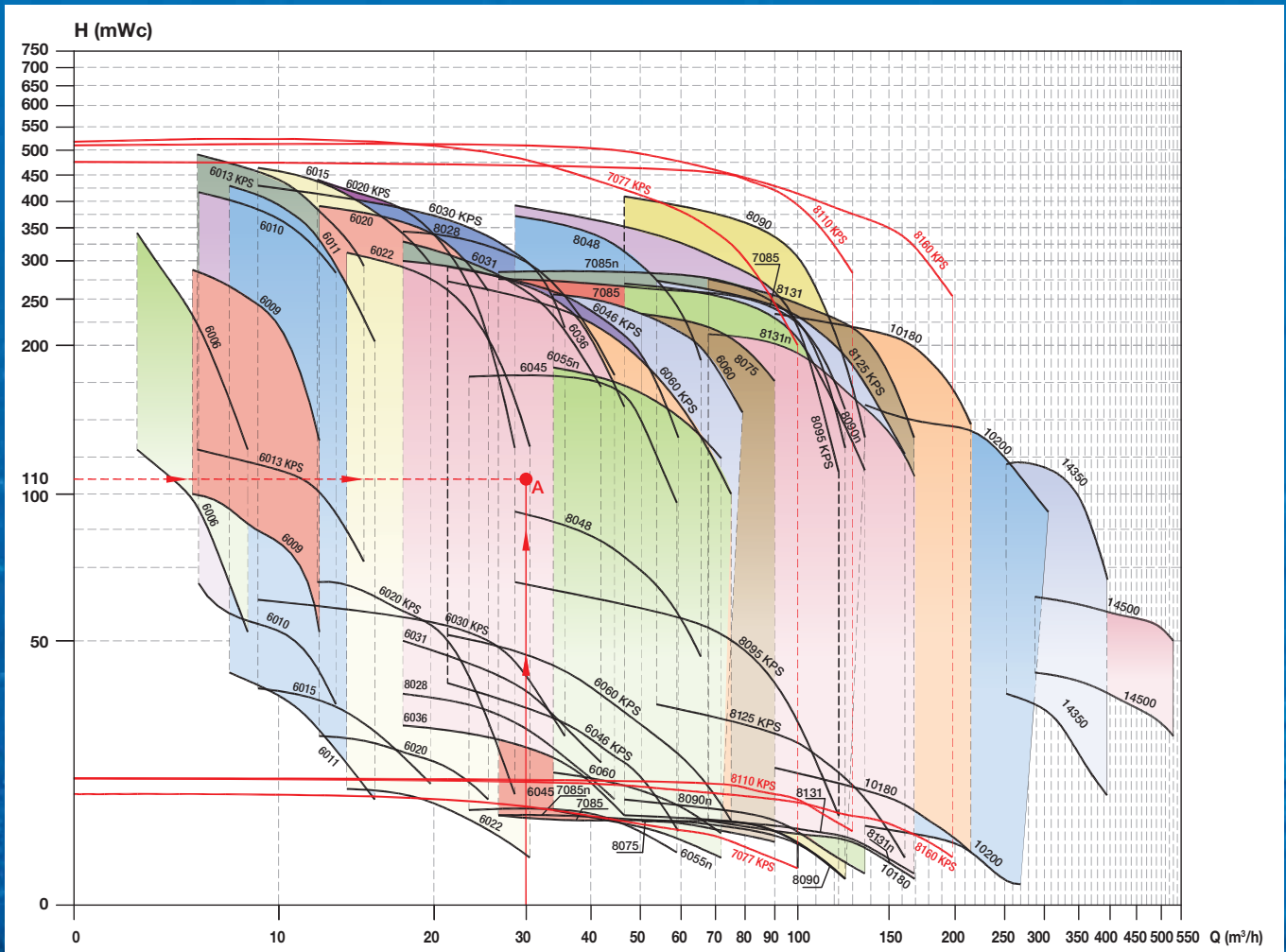

SELECTING PUMP

It is determined that requested intersection point (A) of flow and manometer height is remained in which pump's area from "General Selection Abac" In order to select pump, its "Independent Characteristic Curve" is checked Level number on the upper nearest curve to intersection point of flow and manometer head. According to determined pump type and level, motor type and power are defined from "Electrical Specifications, Dimensions and Weight Table" Pump according to "Order Notation" is demanded from Alarko Carrier vendor with determining electrical switchboard demand and electrical cable length.

SELECTION SAMPLE

Let the well diameter be 8 5/8", the flow-rate (Q) be 46 m³/hour and manometric height (H) be 125 mWc. The points of the 46 m³/hour on the horizontal axis and 125 mWc on the vertical axis are intersected on the "General Selection Chart". The intersection point (A) stays in the region of 6046 KPS type of pump. This leads us to 6046 type pump "Independent Characteristic Curve". The intersection point of the values of 46 m³/hour and 125 mWc is on 15th stage curve. The pump stage is selected as 15. The efficiency of the pump is 74%. The pump type is specified as AL 6-30 using "Electrical Specification, Dimensions and Weights Table". The order notation is specified as 6046/15 KPS+AL 6-30.

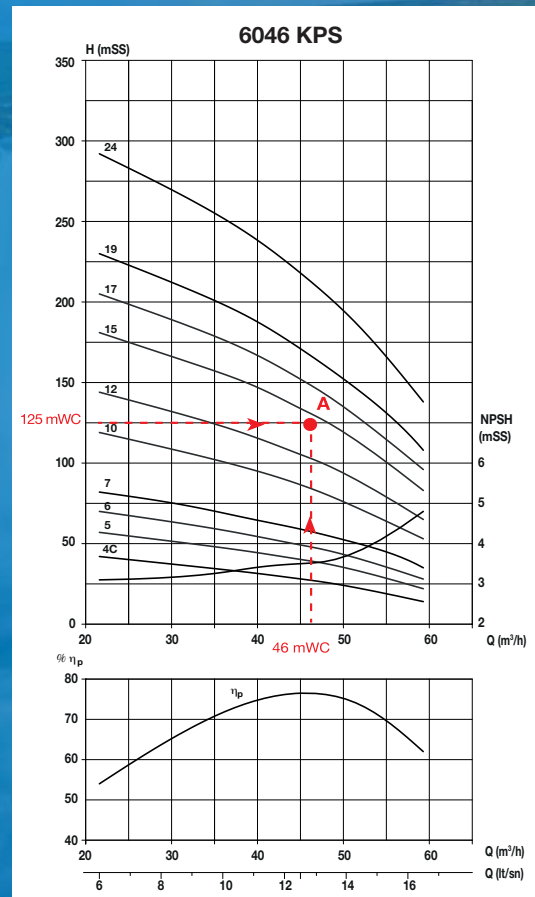

SELECTING CABLE

Rated Voltage	Motor Power		Cable Section (mm ²)											
	kW	HP	4x1.5	4x2.5	4x4	4x6	4x10	3x16+10	3x25+16	3x35+16	3x50+25	3x70+35	3x95+50	
3-Phase 380 V	0.37	0.5	545											
	0.55	0.75	347	575										
	0.75	1	296	490										
	1.1	1.5	199	331	528									
	1.5	2	155	257	411	612								
	2.2	3	108	180	287	429	707							
	3	4	80	133	213	317	522							
	3.7	5	70	125	186	290	420							
	4	5.5	62	104	166	248	400							
	4.4	6	50	82	160	240	260	645	1005					
	5.5	7.5	45	75	119	178	293							
	7.5	10		60	95	145	245	390	610	855				
	11	15		40	66	100	170	275	430	605				
	15	20		30	50	75	130	205	325	455	650			
	18.5	25		35	60	90	155	245	390	545	780			
	22	30		30	50	75	130	205	325	455	650			
	30	40					55	95	155	240	340	485	680	925
	37	50					45	75	125	195	275	390	550	745
45	60						65	100	160	225	325	455	620	
55	75						50	80	130	180	260	365	495	
70	96							65	100	140	205	285	390	
80	110								85	120	170	240	330	
96	130									100	145	205	275	
110	150									85	125	175	240	
132	180										105	145	200	

25 HP and above motors are star-delta. In star-delta motors, 2 of the cables with lengths specified above should be used.

MAIN PARTS

1- Valve Casing: The upper part of the pump. The pump outlet is connected to this part. Extra safety during installation thanks to specific type of ring and extended switch platform originated from material made up of precision cast 304 rustproof steel.

2-Check Valve: Prevents the water in pillar tube from reverse-flowing, which will cause the motor to overturn. Water-hammer reduces any risk of shock.

3-Upper Bearing: Coated with durable chrome material. It reduces abrasion in case the well is surrounded by harsh sand.

4-Labyrinth Rings: Contributes to the efficiency and robustness of high pumps. It has the self-aligning function. It is made up of Teflon.

5-Cable Housing: Made up of peculiarly thinned rustproof steel. It facilitates installation in the wells with less tolerance.

6-In-Pump "Upthrust" Protection: Prevents the pump from getting damaged in case of requirement of much water and in initial launches. It maintains high durability against failures in cases of open valve and frequent stop/launch.

7-Suction Filter: Ensures that the pump is not damaged in case of requirement of much water and in initial launches by preventing the abrasive parts from entering into the pump. It is made up of 304 rustproof steel.

8-Coupling Protective Filter: Prevents the abrasive components from damaging coupling and motor shaft. It is made up of 304 rustproof steel.

9-Suction Case: Ensures that the pump and the motor are interconnected. It ensures excellent pump-motor connection through any type of plunger motor with NEMA standard. The water enters into the pump through the suction opening. It has a suction strainer on the upper side of it, which blocks the chunks.

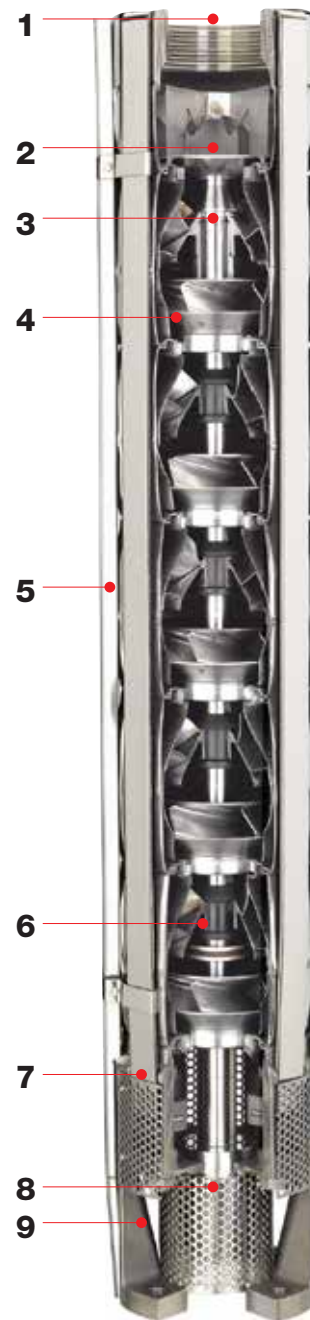

OPTIONAL ELECTRIC BOARD

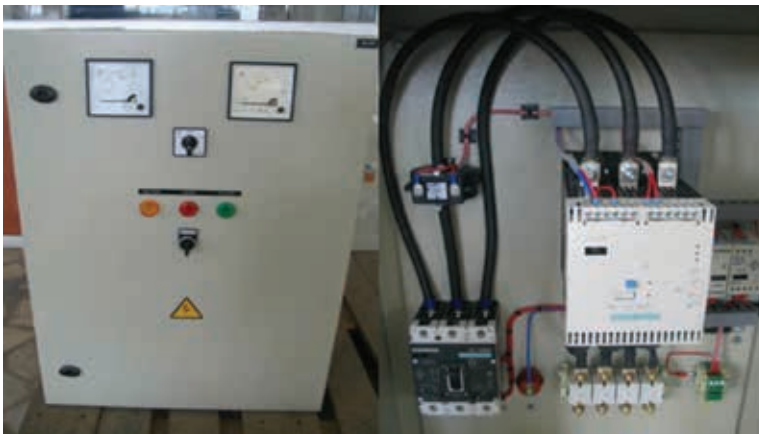

SOFT STARTER CONTROL PANELS

- Reduction in control panel and wiring cost up to 25% average
- Use of single cable instead of double-wire for 25 – 180 HP motor power (Star-Delta connected)
- With the use of single cable ,
 - » An average % 20 reduction in installation time
 - » An average % 50 reduction in cable attachment
- With the use of soft starter panels
 - » Low fault rate and longer pump life
 - » Low water hammer risk
 - » High customer satisfaction

ELECTRICAL SPECIFICATIONS, DIMENSIONS AND WEIGHTS

TYPE Pump + Motor		MOTOR POWER		MOTOR CURRENT (A)	PUMP OUTLET DIAMETER	PUMP+MOTOR LENGTH (mm)	PUMP BODY OUTER DIAMETER (mm)	WEIGHT (Kg)		
		(HP)	(kW)							
6013 KPS /10	+ ALK 6-10	10	7.5	17.5	BSP G2 1/2	1494	148	74		
6013 KPS /14	+ ALK 6-15	15	11	25		1768		91		
6013 KPS /20	+ ALK 6-20	20	15	32		2138		113		
6013 KPS /24	+ ALK 6-25	25	18.5	42		2398		129		
6013 KPS /29	+ ALK 6-30	30	22	51		2643		142		
6013 KPS /34	+ ALK 6-40	40	30	63		2968		164		
6020 KPS /7	+ ALK 6-7.5	7.5	5.5	13	BSP G2 1/2	1336	144	59		
6020 KPS /10	+ ALK 6-10	10	7.5	17.5		1571		71		
6020 KPS /13	+ ALK 6-12.5	12.5	9	20.5		1776		81		
6020 KPS /15	+ ALK 6-15	15	11	25		1940		89		
6020 KPS /18	+ ALK 6-17.5	17.5	13	29		2147		96		
6020 KPS /20	+ ALK 6-20	20	15	32		2327		107		
6020 KPS /25	+ ALK 6-25	25	18.5	42		2682		122		
6020 KPS /30	+ ALK 6-30	30	22	51		2977		132		
6020 KPS /34	+ ALK 6-35	35	26	56		3257		145		
6020 KPS /40	+ ALK 6-40	40	30	63		3627		160		
6020 KPS /44	+ ALK 6-50	50	37	80		3987		179		
6030 KPS /6	+ ALK 6-7.5	7.5	5.5	13		BSP G3		1530	145	61
6030 KPS /8	+ ALK 6-10	10	7.5	17.5	1792		71			
6030 KPS /11	+ ALK 6-12.5	12.5	9	20.5	2120		79			
6030 KPS /13	+ ALK 6-15	15	11	25	2366		89			
6030 KPS /15	+ ALK 6-17.5	17.5	13	29	2588		95			
6030 KPS /17	+ ALK 6-20	20	15	32	2850		105			
6030 KPS /21	+ ALK 6-25	25	18.5	42	3314		120			
6030 KPS /26	+ ALK 6-30	30	22	51	3814		131			
6030 KPS /30	+ ALK 6-35	35	26	56	4265		145			
6030 KPS /35	+ ALK 6-40	40	30	63	4785		159			
6030 KPS /39	+ ALK 6-50	50	37	80	5309		205			
6046 KPS /4C	+ ALK 6-7.5	7.5	5.5	13	BSP G4		1388	149,7		59
6046 KPS /5	+ ALK 6-10	10	7.5	17.5		1587	70			
6046 KPS /6	+ ALK 6-12.5	12.5	9	20.5		1740	76			
6046 KPS /7	+ ALK 6-15	15	11	25		1907	85			
6046 KPS /10	+ ALK 6-20	20	15	32		2652	103			
6046 KPS /12	+ ALK 6-25	25	18.5	42		3011	117			
6046 KPS /15	+ ALK 6-30	30	22	51		3297	128			
6046 KPS /17	+ ALK 6-35	35	26	56		3676	139			
6046 KPS /19	+ ALK 6-40	40	30	63		3563	149			
6046 KPS /24	+ ALK 6-50	50	37	80		4970	190			
6060 KPS /4	+ ALK 6-10	10	7.5	18		BSP G4	1474		149,7	66
6060 KPS /6	+ ALK 6-15	15	11	25			1794			82
6060 KPS /7	+ ALK 6-17.5	17.5	13	28	1937		88			
6060 KPS /8	+ ALK 6-20	20	15	33	2120		97			
6060 KPS /10	+ ALK 6-25	25	18.5	41	2426		110			
6060 KPS /12	+ ALK 6-30	30	22	48	2672		118			
6060 KPS /15	+ ALK 6-35	35	26	55	3071		133			
6060 KPS /17	+ ALK 6-40	40	30	63	3337		143			
6060 KPS /21	+ ALK 6-50	50	37	75	4009		168			
7077 KPS /1	+ ALK 6-7.5	7.5	5.5	13	4" - 5"		1330	185		66
7077 KPS /2	+ ALK 6-10	10	7.5	18			1505			76
7077 KPS /3	+ ALK 6-15	15	11	25			1695			87
7077 KPS /4	+ ALK 6-20	20	15	35		1915	102			
7077 KPS /5	+ ALK 6-25	25	18.5	42		2130	116			
7077 KPS /6	+ ALK 6-30	30	22	51		2305	126			
7077 KPS /7	+ ALK 6-35	35	26	58		2540	142			
7077 KPS /9	+ ALK 6-40	40	30	66		2910	163			
7077 KPS /11	+ ALK 6-50	50	37	81		3260	184			
7077 KPS /12	+ ALK 7-60	60	45	91		3167	200			
7077 KPS /16	+ ALK 7-80	80	59	119		3873	247			
7077 KPS /18	+ ALK 8-90	90	66	131		4110	286			
7077 KPS /21	+ ALK 8-100	100	75	147	4595	317				
7077 KPS /24	+ ALK 8-125	125	92	182	5185	368				
7077 KPS /26	+ ALK 10-150	150	110	166	5314	445				
8095 KPS /4-B	+ ALK 6-20	20	15	32	BSP G5	1947	189	107		
8095 KPS /4	+ ALK 6-25	25	18.5	42		2027		115		
8095 KPS /5	+ ALK 6-30	30	22	51		2175		121		
8095 KPS /6	+ ALK 6-35	35	26	56		2636		132		
8095 KPS /7	+ ALK 6-40	40	30	63		2531		141		
8095 KPS /9	+ ALK 6-50	50	37	80		2926		161		
8095 KPS /10	+ ALK 8-60	60	45	90		2900		202		
8095 KPS /13	+ ALK 8-75	75	55	112		3367		227		
8095 KPS /16	+ ALK 8-90	90	66	131		3862		257		
8095 KPS /17	+ ALK 8-100	100	75	147		4060		276		
8095 KPS /18	+ ALK 8-110	110	81	161		4279		296		
8095 KPS /20	+ ALK 8-125	125	92	182		4645		325		
8110 KPS /1	+ ALK 6-10	10	7.5	18	6"	1440	214	78		
8110 KPS /2	+ ALK 6-20	20	15	35		1745		101		
8110 KPS /3	+ ALK 6-30	30	22	51		2030		122		
8110 KPS /4	+ ALK 6-40	40	30	66		2400		151		
8110 KPS /5	+ ALK 6-50	50	37	81		2670		169		
8110 KPS /6	+ ALK 8-60	60	45	90		2575		207		
8110 KPS /7	+ ALK 8-75	75	55	112		2810		229		
8110 KPS /8	+ ALK 8-80	80	59	117		2975		238		
8110 KPS /9	+ ALK 8-90	90	66	131		3230		263		
8110 KPS /10	+ ALK 8-100	100	75	147		3455		285		
8110 KPS /11	+ ALK 8-110	110	81	161		3700		308		
8110 KPS /13	+ ALK 8-125	125	92	182		4120		342		
8110 KPS /15	+ ALK 10-150	150	110	220	4299	424				
8110 KPS /18	+ ALK 10-175	175	129	255	4864	473				
8110 KPS /20	+ ALK 10-200	200	147	290	5294	510				
8125 KPS /2-AA	+ ALK 6-17.5	17.5	13	29	BSP G6	1686	209	94		
8125 KPS /2-A	+ ALK 6-25	25	18.5	42		1836		109		
8125 KPS /3-AA	+ ALK 6-30	30	22	51		2012		123		
8125 KPS /3	+ ALK 6-40	40	30	63		2112		135		
8125 KPS /4	+ ALK 6-50	50	37	80		2408		157		
8125 KPS /5-A	+ ALK 8-60	60	45	90		2412		201		
8125 KPS /6-A	+ ALK 8-75	75	55	112		2648		221		
8125 KPS /7	+ ALK 8-90	90	66	131		2914		248		
8125 KPS /8	+ ALK 8-100	100	75	147		3140		268		
8125 KPS /9-AA	+ ALK 8-110	110	81	161		3386		290		
8125 KPS /10	+ ALK 8-125	125	92	182		3652		315		
8160 KPS /1Z	+ ALK6-12.5	12.5	9.2	21		6"		1470	214	82
8160 KPS /1	+ ALK6-17.5	17.5	13	31	1550		90			
8160 KPS /2ZZ	+ ALK6-25	25	18.5	42	1830		111			
8160 KPS /2Z	+ ALK6-30	30	22	51	1875		116			
8160 KPS /2	+ ALK6-35	35	26	58	1980		127			
8160 KPS /3ZZ	+ ALK6-40	40	30	66	2245		145			
8160 KPS /3	+ ALK8-50	50	37	76	2060		178			
8160 KPS /4Z	+ ALK8-60	60	45	90	2265		194			
8160 KPS /5Z	+ ALK8-75 7	5	55	112	2500		216			
8160 KPS /5	+ ALK8-90	90	66	131	2610		236			
8160 KPS /7ZZ	+ ALK8-100	100	75	147	2990		266			
8160 KPS /8	+ ALK8-125	125	92	182	3345		309			
8160 KPS /9	+ ALK10-150	150	110	220	3369	384				
8160 KPS /11	+ ALK10-175	175	129	255	3779	427				
8160 KPS /12	+ ALK10-200	200	147	290	4054	457				
8160 KPS /14	+ ALK10-225	225	165	325	4434	514				
8160 KPS /16	+ ALK10-250	250	185	355	4844	558				

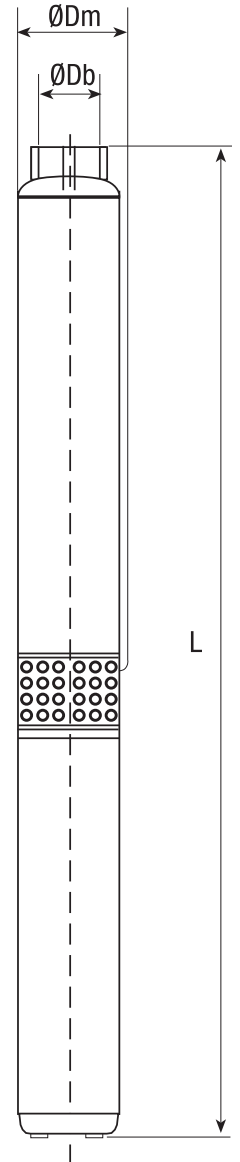

6013 KPS

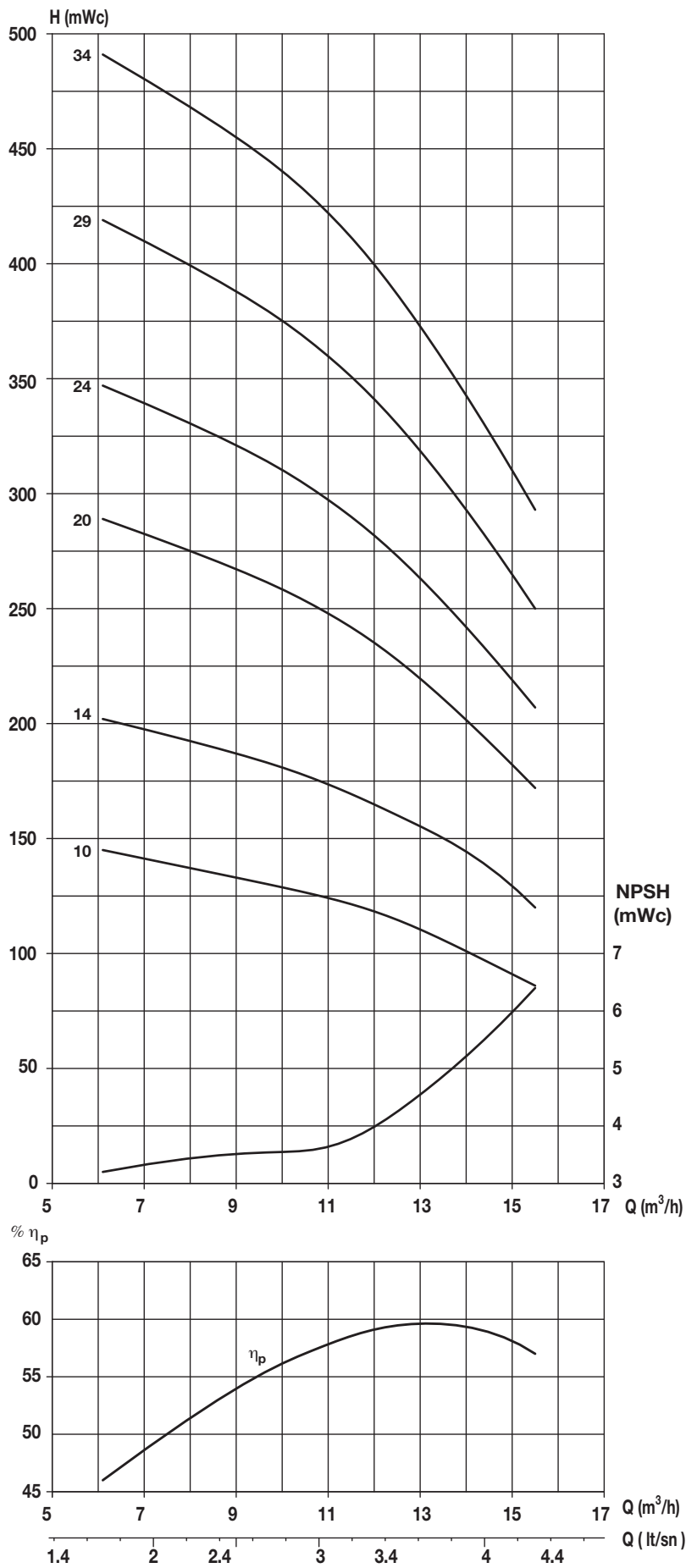



PUMP TYPE	MOTOR TYPE kW/HP	FLOW		6,1	9,0	10,8	12,6	14,4	15,5
		NPSH	(m ³ / h)	1,7	2,5	3	3,5	4	4,3
			(mWc)	3,2	3,5	3,6	4,3	5,5	6,4
6013 KPS/9	ALK 6-7.5 kW /10 HP	⇒	130	120	113	103	87	77	
6013 KPS/10	ALK 6-7.5 kW /10 HP		145	133	125	114	97	86	
6013 KPS/12	ALK 6-11 kW /15 HP		174	160	150	137	116	103	
6013 KPS/13	ALK 6-11 kW /15 HP		188	174	163	148	126	112	
6013 KPS/14	ALK 6-11 kW /15 HP		202	187	175	159	136	120	
6013 KPS/17	ALK 6-15 kW /20 HP		246	227	213	193	165	147	
6013 KPS/20	ALK 6-15 kW /20 HP		289	267	250	226	194	172	
6013 KPS/24	ALK 6-18.5 kW /25 HP		347	321	300	271	233	207	
6013 KPS/25	ALK 6-22 kW /30 HP		362	334	313	283	243	215	
6013 KPS/27	ALK 6-22 kW /30 HP		390	361	338	305	262	233	
6013 KPS/29	ALK 6-22 kW /30 HP		419	388	363	328	282	250	
6013 KPS/34	ALK 6-30 kW /40 HP		491	455	426	384	330	293	

**Maximum
efficiency point**

6020 KPS

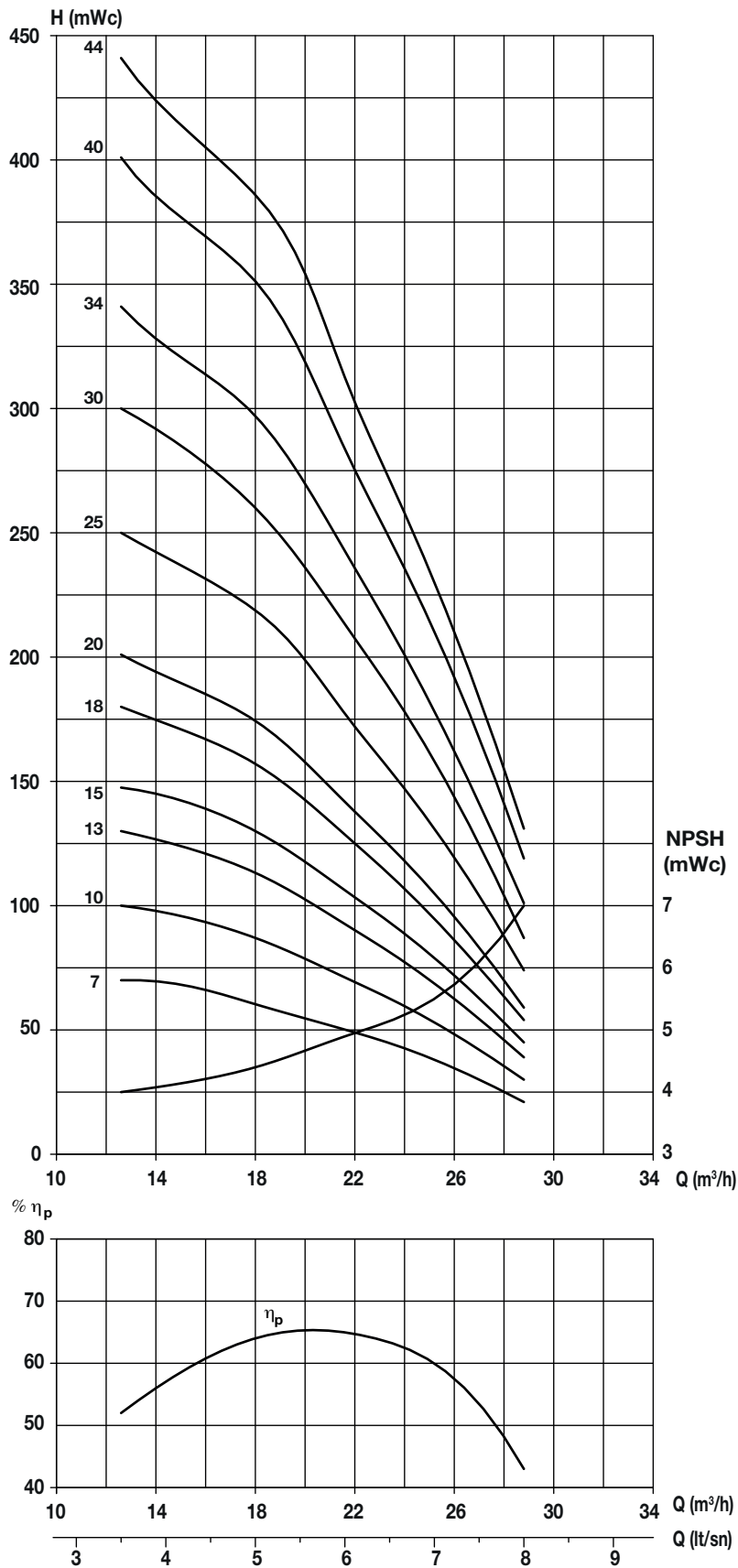



PUMP TYPE	MOTOR TYPE kW/HP	FLOW		12,6	14,4	18,0	21,6	25,2	28,8
			(m ³ / h)						
		NPSH	(lt / sn)				6,0	7,0	8,0
			(mWc)	4	4,1	4,4	4,9	5,5	7
6020 KPS /7	ALK 6-5.5 kW /7.5 HP			70	69	60	50	38	21
6020 KPS /9	ALK 6-7.5 kW /10 HP			90	88	78	64	48	27
6020 KPS /10	ALK 6-7.5 kW /10 HP			100	97	87	71	53	30
6020 KPS /11	ALK 6-9 kW /12.5 HP			110	107	95	78	59	33
6020 KPS /12	ALK 6-9 kW /12.5 HP			120	116	104	85	64	36
6020 KPS /13	ALK 6-9 kW /12.5 HP			130	126	113	92	69	39
6020 KPS /14	ALK 6-11 kW /15 HP			140	135	122	99	74	42
6020 KPS /15	ALK 6-11 kW /15 HP			148	144	130	106	79	45
6020 KPS /16	ALK 6-13 kW /17.5 HP			160	154	139	114	85	48
6020 KPS /17	ALK 6-13 kW /17.5 HP			170	164	148	121	90	51
6020 KPS /18	ALK 6-13 kW /17.5 HP			180	173	157	128	95	54
6020 KPS /19	ALK 6-15 kW /20 HP			190	183	166	135	100	57
6020 KPS /20	ALK 6-15 kW /20 HP			201	192	174	142	105	59
6020 KPS /21	ALK 6-18.5 kW /25 HP			210	202	184	149	111	63
6020 KPS /22	ALK 6-18.5 kW /25 HP		⇒	220	211	192	156	116	66
6020 KPS /23	ALK 6-18.5 kW /25 HP			230	221	201	163	121	68
6020 KPS /24	ALK 6-18.5 kW /25 HP			240	230	210	170	126	71
6020 KPS /25	ALK 6-18.5 kW /25 HP			250	240	219	177	131	74
6020 KPS /27	ALK 6-22 kW /30 HP			271	259	236	191	142	80
6020 KPS /28	ALK 6-22 kW /30 HP			281	268	245	199	147	83
6020 KPS /29	ALK 6-22 kW /30 HP			291	278	254	206	152	86
6020 KPS /30	ALK 6-22 kW /30 HP			300	289	260	213	158	88
6020 KPS /32	ALK 6-26 kW /35 HP			321	306	281	227	168	95
6020 KPS /34	ALK 6-26 kW /35 HP			341	325	298	241	178	101
6020 KPS /36	ALK 6-30 kW /40 HP			361	344	316	255	189	107
6020 KPS /38	ALK 6-30 kW /40 HP			381	363	333	269	199	113
6020 KPS /40	ALK 6-30 kW /40 HP			401	382	351	284	210	119
6020 KPS /42	ALK 6-37 kW /50 HP			421	401	369	298	220	125
6020 KPS /44	ALK 6-37 kW /50 HP			441	420	386	312	230	131

**Maximum
efficiency point**

6030 KPS

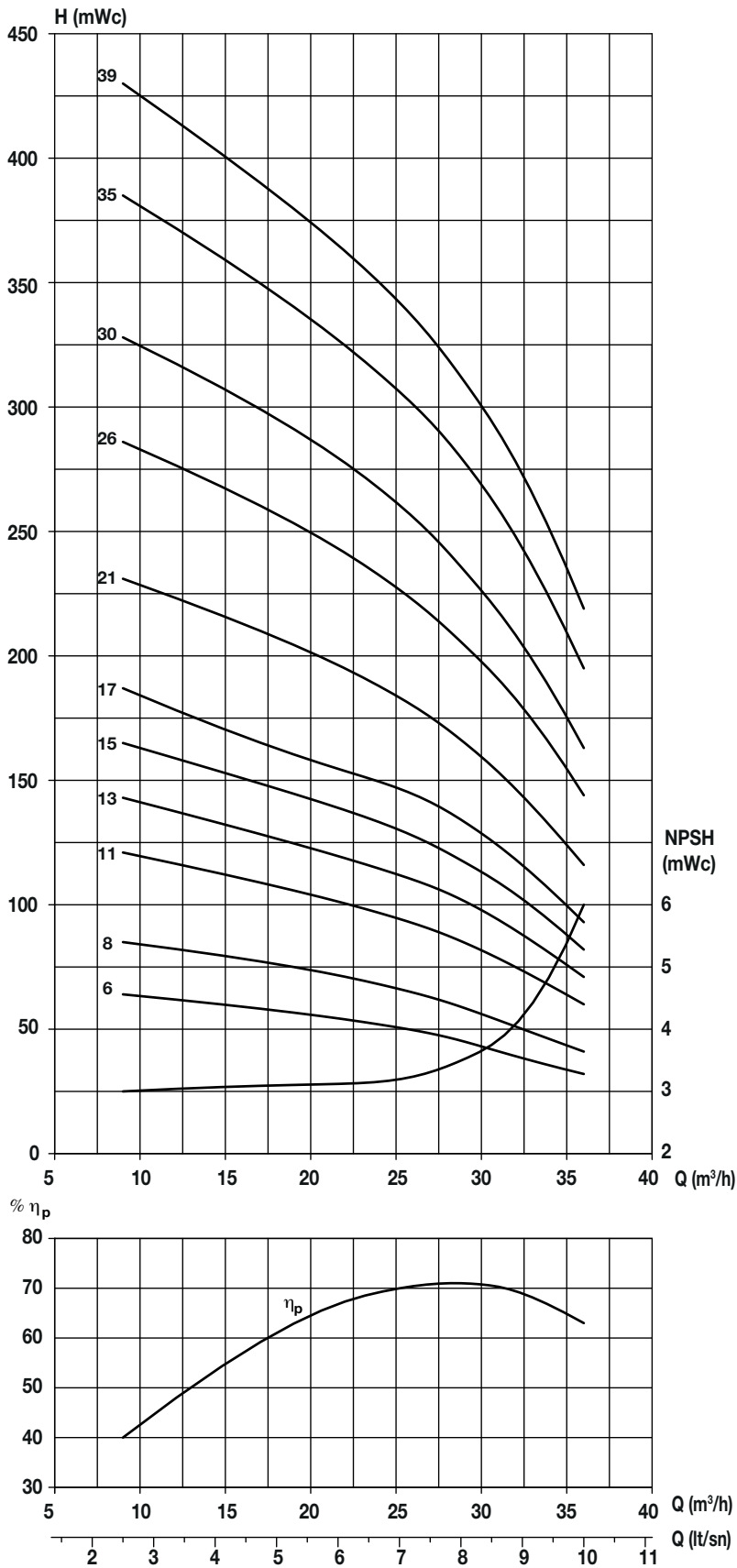



PUMP TYPE	MOTOR TYPE kW/HP	FLOW		(m ³ / h)	9	18	25,2	28,8	32,4	36
		NPSH	(mWc)	(lt / sn)	2,5	5,0	7,0	8,0	9,0	10,0
			(mWc)	3	3,1	3,2	3,5	4,2	6	
6030 KPS /6	ALK 6-5.5 kW /7.5 HP	H (mWc)	⇒	64	58	51	46	38	32	
6030 KPS /7	ALK 6-7.5 kW /10 HP			75	68	59	54	45	37	
6030 KPS /8	ALK 6-7.5 kW /10 HP			85	76	66	59	50	41	
6030 KPS /9	ALK 6-9 kW /12.5 HP			99	88	77	70	60	48	
6030 KPS /10	ALK 6-9 kW /12.5 HP			110	97	86	78	67	54	
6030 KPS /11	ALK 6-9 kW /12.5 HP			121	108	95	86	74	60	
6030 KPS /12	ALK 6-11 kW /15 HP			128	115	100	90	77	61	
6030 KPS /13	ALK 6-11 kW /15 HP			143	127	112	102	88	71	
6030 KPS /14	ALK 6-13 kW /17.5 HP			154	137	121	110	95	77	
6030 KPS /15	ALK 6-13 kW /17.5 HP			165	147	130	118	102	82	
6030 KPS /16	ALK 6-15 kW /20 HP			176	157	135	122	106	85	
6030 KPS /17	ALK 6-15 kW /20 HP			187	167	147	134	116	93	
6030 KPS /18	ALK 6-18.5 kW /25 HP			198	177	156	142	123	99	
6030 KPS /19	ALK 6-18.5 kW /25 HP			209	187	165	150	130	105	
6030 KPS /20	ALK 6-18.5 kW /25 HP			222	198	174	159	138	112	
6030 KPS /21	ALK 6-18.5 kW /25 HP			231	207	183	166	144	116	
6030 KPS /22	ALK 6-22 kW /30 HP			242	217	192	174	151	122	
6030 KPS /23	ALK 6-22 kW /30 HP			248	220	195	178	155	124	
6030 KPS /24	ALK 6-22 kW /30 HP			264	236	209	190	165	133	
6030 KPS /26	ALK 6-22 kW /30 HP			286	256	227	206	179	144	
6030 KPS /28	ALK 6-26 kW /35 HP			308	276	244	222	193	155	
6030 KPS /30	ALK 6-26 kW /35 HP			328	295	261	236	204	163	
6030 KPS /32	ALK 6-30 kW /40 HP			352	316	280	254	222	178	
6030 KPS /35	ALK 6-30 kW /40 HP			385	345	306	279	243	195	
6030 KPS /39	ALK 6-37 kW /50 HP			430	385	342	312	273	219	



**Maximum
efficiency point**

6046 KPS

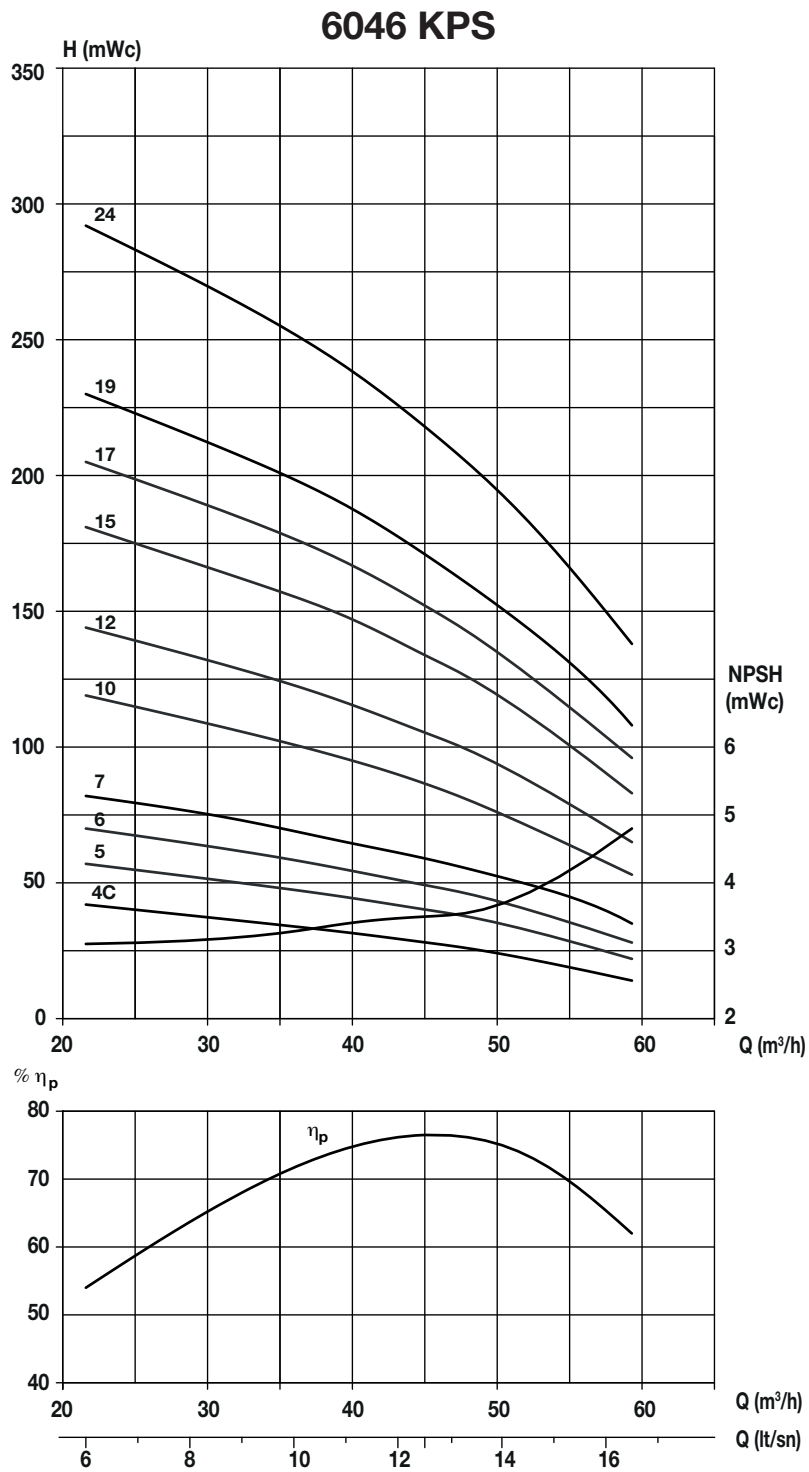



PUMP TYPE	MOTOR TYPE kW/HP	FLOW		(m³ / h)	21,6	32,4	39,6	45	50,4	59,4
				(ft / sn)	6,0	9,0	11,0	12,5	14,0	16,5
		NPSH	(mWc)	3,1	3,2	3,4	3,5	3,7	4,8	
6046 KPS /4-C	ALK 6-5.5 kW /7.5 HP	H (mWc)	⇒	42	36	32	28	24	14	
6046 KPS /5	ALK 6-7.5 kW /10 HP			57	50	45	40	35	22	
6046 KPS /6	ALK 6-9 kW /12.5 HP			70	62	55	49	43	28	
6046 KPS /7	ALK 6-11 kW /15 HP			82	73	65	59	52	35	
6046 KPS /8	ALK 6-15 kW /20 HP			95	86	77	70	62	42	
6046 KPS /9	ALK 6-15 kW /20 HP			107	95	86	77	68	47	
6046 KPS /10	ALK 6-15 kW /20 HP			119	106	96	87	76	53	
6046 KPS /11	ALK 6-18.5 kW /25 HP			131	118	106	96	85	59	
6046 KPS /12	ALK 6-18.5 kW /25 HP			144	129	117	105	93	65	
6046 KPS /13	ALK 6-22 kW /30 HP			156	140	127	115	101	71	
6046 KPS /14	ALK 6-22 kW /30 HP			167	150	136	123	109	76	
6046 KPS /15	ALK 6-22 kW /30 HP			181	162	148	133	118	83	
6046 KPS /17	ALK 6-26 kW /35 HP			205	185	168	152	134	96	
6046 KPS /19	ALK 6-30 kW /40 HP			230	207	189	171	151	108	
6046 KPS /21	ALK 6-37 kW /50 HP			255	230	209	190	168	120	
6046 KPS /23	ALK 6-37 kW /50 HP			280	252	230	208	184	132	
6046 KPS /24	ALK 6-37 kW /50 HP	292	263	240	218	193	138			



**Maximum
efficiency point**

6060 KPS

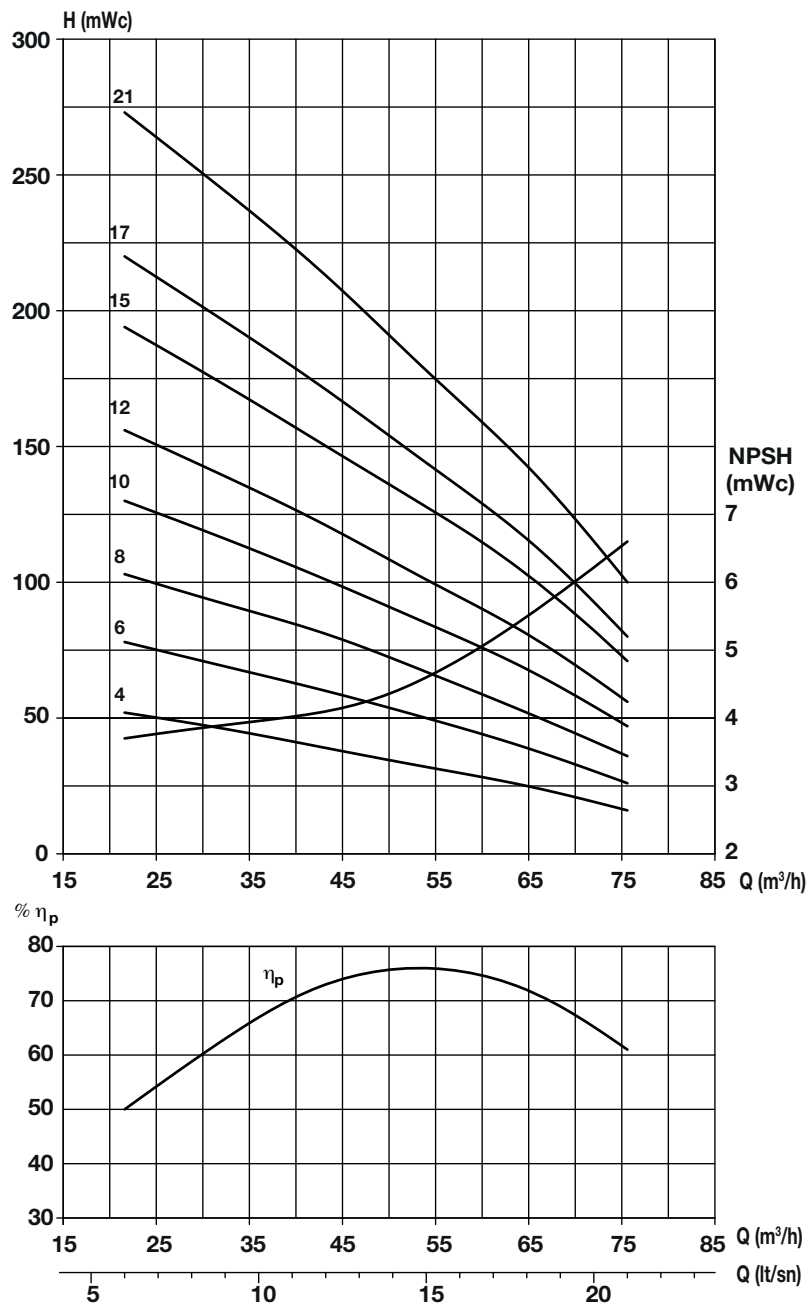



PUMP TYPE	MOTOR TYPE kW/HP	FLOW		(m ³ / h)	21,6	32,4	43,2	54	64,8	75,6
				(lt / sn)	6,0	9,0	12,0	15,0	18,0	21,0
		NPSH	(mWc)	3,7	3,9	4,1	4,6	5,5	6,6	
6060 KPS / 4	ALK 6-7.5 kW /10 HP	H (mWc)	⇒	52	46	39	32	25	16	
6060 KPS / 6	ALK 6-11 kW /15 HP			78	69	60	50	39	26	
6060 KPS / 8	ALK 6-15 kW /20 HP			103	92	81	67	52	36	
6060 KPS / 10	ALK 6-18.5 kW /25 HP			130	116	101	85	68	47	
6060 KPS / 12	ALK 6-22 kW /30 HP			156	139	121	101	81	56	
6060 KPS / 14	ALK 6-26 kW /35 HP			183	163	142	120	96	67	
6060 KPS / 15	ALK 6-26 kW /35 HP			194	173	150	128	103	71	
6060 KPS / 16	ALK 6-30 kW /40 HP			209	186	163	137	110	77	
6060 KPS / 17	ALK 6-30 kW /40 HP			220	196	171	144	116	80	
6060 KPS / 19	ALK 6-37 kW /50 HP			248	222	193	163	132	92	
6060 KPS / 20	ALK 6-37 kW /50 HP			261	233	204	172	139	97	
6060 KPS / 21	ALK 6-37 kW /50 HP			273	244	213	178	143	100	

**Maximum
efficiency point**

7077 KPS

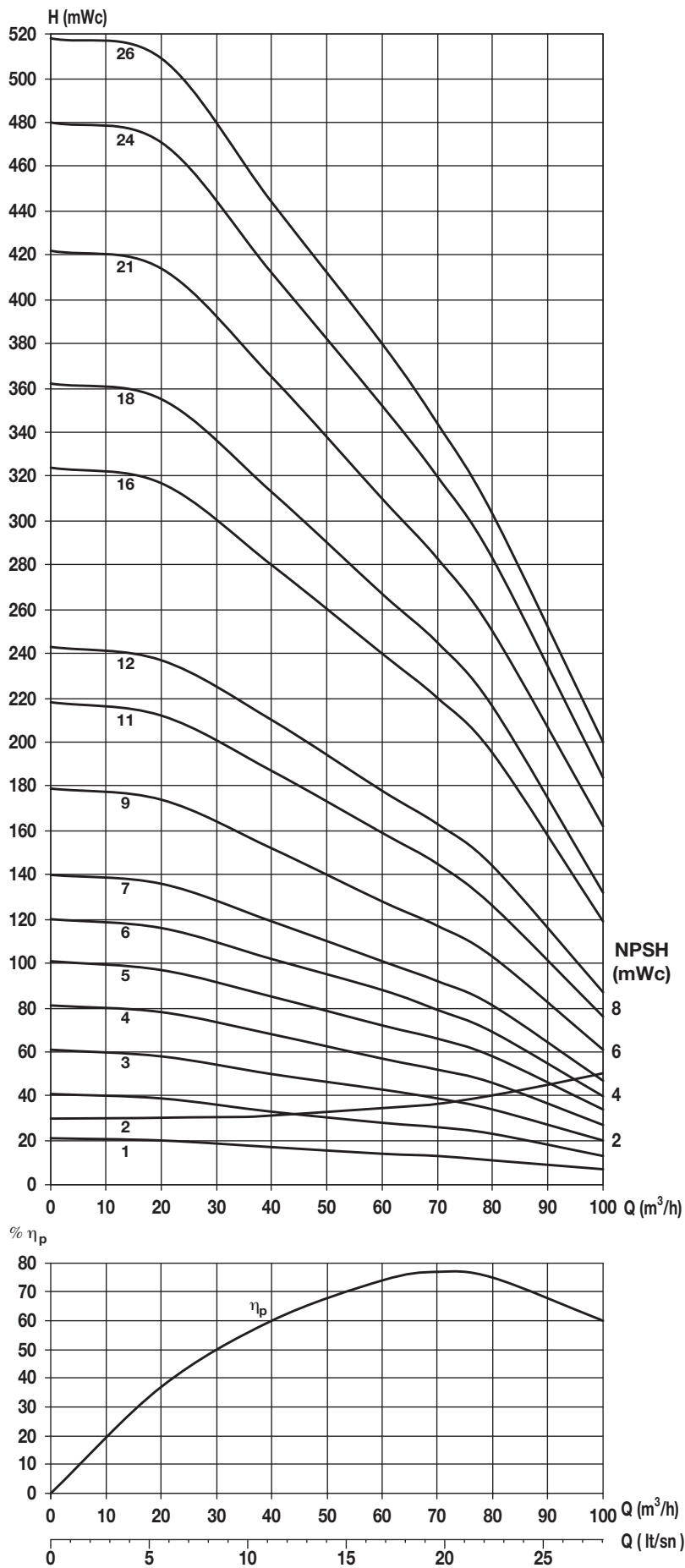



PUMP TYPE	MOTOR TYPE kW/HP	FLOW		0	20	40	60	70	80	100
			(m ³ / h)	6,0	9,0	12,0	16,7	19,4	22,2	27,8
		NPSH	(mWc)	3,7	3,9	4,1	3,5	3,6	4,0	5,0
7077 KPS / 1	ALK 6-5,5 kW Y	H (mWc)	⇒	21	20	17	14	13	11	7
7077 KPS / 2	ALK 6-7,5 kW Y			41	39	33	28	26	23	13
7077 KPS / 3	ALK 6-11 kW Y			61	58	50	43	39	34	20
7077 KPS / 4	ALK 6-15 kW Ü			81	78	68	57	52	46	27
7077 KPS / 5	ALK 6-18,5 kW Y/Ü			101	97	85	72	66	58	34
7077 KPS / 6	ALK 6-22 kW Y/Ü			120	116	102	88	79	69	40
7077 KPS / 7	ALK 6-26 kW Y/Ü			140	136	119	101	92	81	47
7077 KPS / 9	ALK 6-30 kW Y/Ü			179	174	152	128	117	103	61
7077 KPS / 11	ALK 6-37 kW Y/Ü			218	212	187	159	145	126	76
7077 KPS / 12	ALK 7-45 kW Y/Ü			243	237	210	178	163	144	87
7077 KPS / 16	ALK 7-59 kW Y/Ü			324	317	280	240	220	195	119
7077 KPS / 18	ALK 8-66 kW Y/Ü			362	355	313	267	245	216	132
7077 KPS / 21	ALK 8-75 kW Y/Ü			422	414	365	310	283	250	162
7077 KPS / 24	ALK 8-92 kW Y/Ü	480	471	412	352	320	283	184		
7077 KPS / 26	ALK 10-110 kW Y/Ü	518	509	444	380	344	303	200		



**Maximum
efficiency point**

8095 KPS

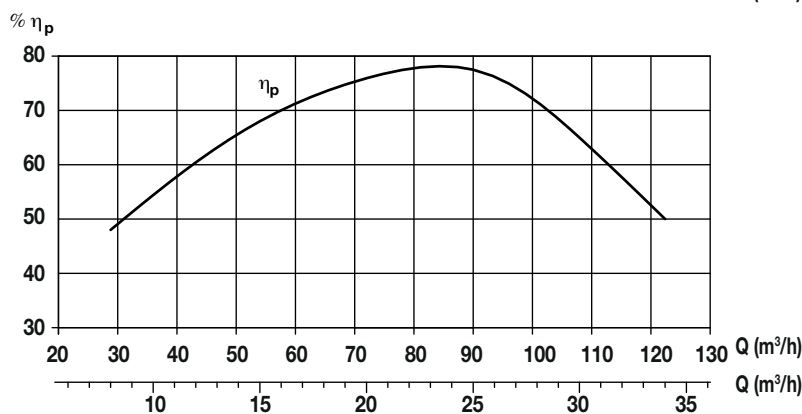
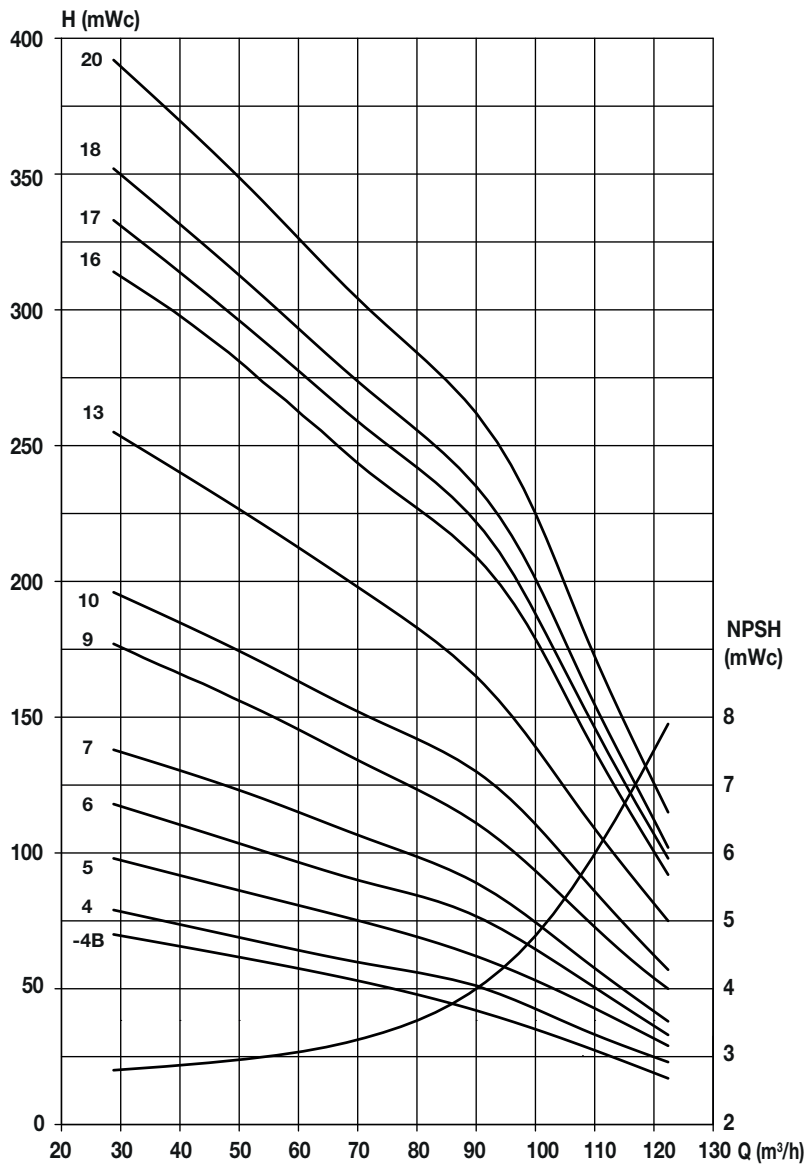



PUMP TYPE	MOTOR TYPE kW/HP	FLOW		(m ³ / h)	28,8	54	72	90	108	122,4
				(lt / sn)	8,0	15,0	20,0	25,0	30,0	34,0
		NPSH	(mWc)	2,8	3	3,3	4,0	5,7	7,9	
8095 KPS/ 04-B	ALK 6-15 kW /20 HP	H (mWc)	⇒	70	60	52	42	29	17	
8095 KPS / 04	ALK 6-18.5 kW /25 HP			79	67	59	51	35	23	
8095 KPS / 05	ALK 6-22 kW /30 HP			98	84	74	62	45	29	
8095 KPS / 06	ALK 6-26 kW /35 HP			118	101	89	77	53	33	
8095 KPS / 07	ALK 6-30 kW /40 HP			138	120	105	89	61	38	
8095 KPS / 08	ALK 6-37 kW /50 HP			157	135	119	104	72	46	
8095 KPS / 09	ALK 6-37 kW /50 HP			177	152	132	111	77	50	
8095 KPS / 10	ALK 8-45 kW /60 HP			196	170	150	130	91	57	
8095 KPS / 11	ALK 8-55 kW /75 HP			216	187	165	144	100	63	
8095 KPS / 12	ALK 8-55 kW /75 HP			237	205	180	158	110	72	
8095 KPS / 13	ALK 8-55 kW /75 HP			255	221	195	165	115	75	
8095 KPS / 14	ALK 8-66 kW /90 HP			275	238	210	183	128	80	
8095 KPS / 15	ALK 8-66 kW /90 HP			294	255	225	196	137	86	
8095 KPS / 16	ALK 8-66 kW /90 HP			314	272	240	209	146	92	
8095 KPS / 17	ALK 8-75 kW /100 HP			333	289	255	223	155	98	
8095 KPS / 18	ALK 8-81 kW /110 HP			352	305	270	235	164	102	
8095 KPS / 19	ALK 8-92 kW /125 HP			373	323	285	249	174	109	
8095 KPS / 20	ALK 8-92 kW /125 HP			392	340	300	262	183	115	

**Maximum
efficiency point**

8110 KPS

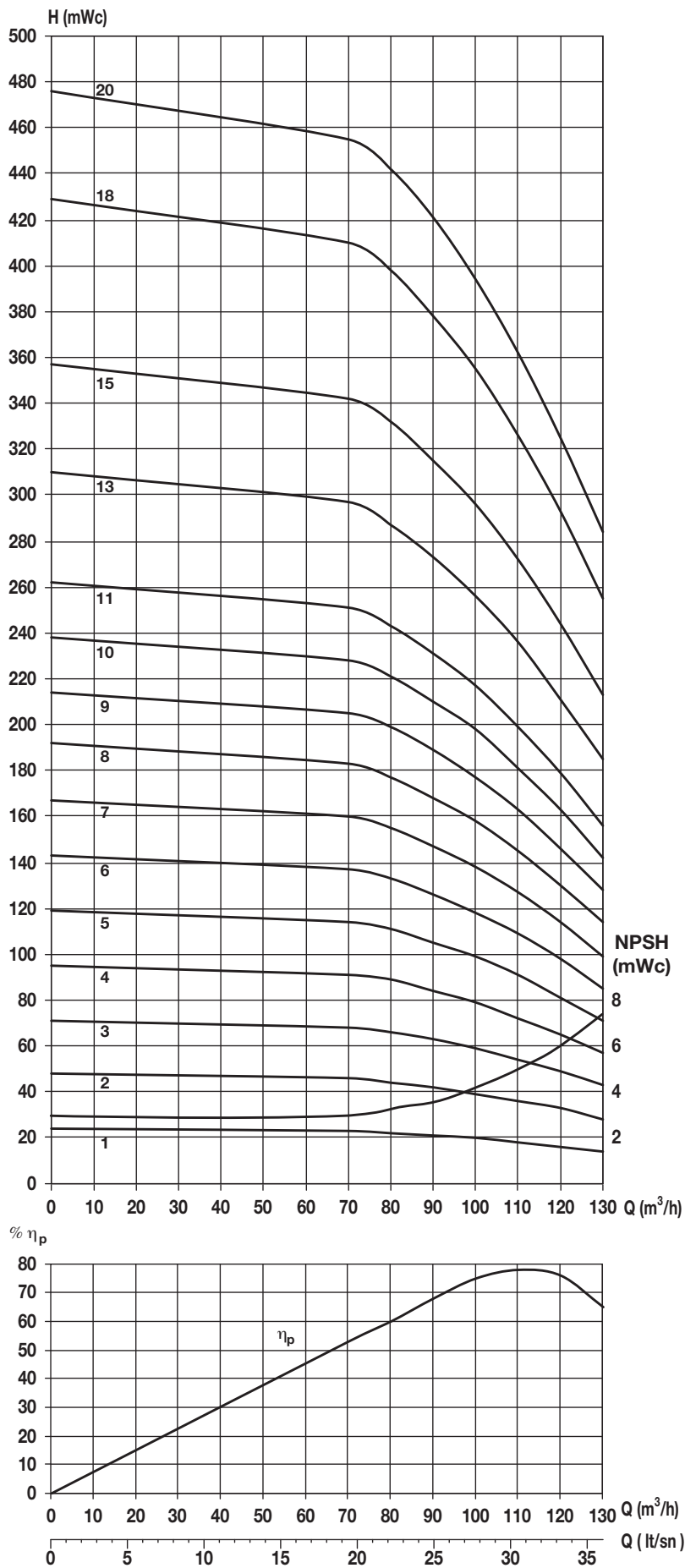



PUMP TYPE	MOTOR TYPE kW/HP	FLOW		(m ³ / h)	0	70	80	90	100	110	120	130
				(lt / sn)	0	19,4	22,2	25,0	27,8	30,6	33,3	36,1
		NPSH	(mWc)	3,0	3,0	3,3	3,6	4,2	5,0	6,0	7,4	
8110 KPS / 1	ALK 6-7.5kW Y	H (mWc)	⇒	24	23	22	21	20	18	16	14	
8110 KPS / 2	ALK 6-15kW Ü			48	46	44	42	39	36	33	28	
8110 KPS / 3	ALK 6-22kW Y/Ü			71	68	66	63	59	54	49	43	
8110 KPS / 4	ALK 6-30kW Y/Ü			95	91	89	84	79	72	65	57	
8110 KPS / 5	ALK 6-37kW Y/Ü			119	114	111	105	99	91	81	71	
8110 KPS / 6	ALK 8-45 kW Y/Ü			143	137	133	126	118	109	98	85	
8110 KPS / 7	ALK 8-55 kW Y/Ü			167	160	155	147	138	127	114	99	
8110 KPS / 8	ALK 8-59 kW Y/Ü			192	183	177	168	158	145	130	114	
8110 KPS / 9	ALK 8-66 kW Y/Ü			214	205	199	189	177	163	146	128	
8110 KPS / 10	ALK 8-75 kW Y/Ü			238	228	221	210	198	181	163	142	
8110 KPS / 11	ALK 8-81 kW Y/Ü			262	251	243	231	217	199	179	156	
8110 KPS / 13	ALK 8-92 kW Y/Ü			310	297	287	273	256	236	211	185	
8110 KPS / 15	ALK 10-110 kW Y/Ü			357	342	332	315	296	272	244	213	
8110 KPS / 18	ALK 10-129 kW Y/Ü			429	410	398	378	355	326	293	255	
8110 KPS / 20	ALK 10-147 kW Y/Ü			476	455	442	421	394	362	325	284	



8125 KPS

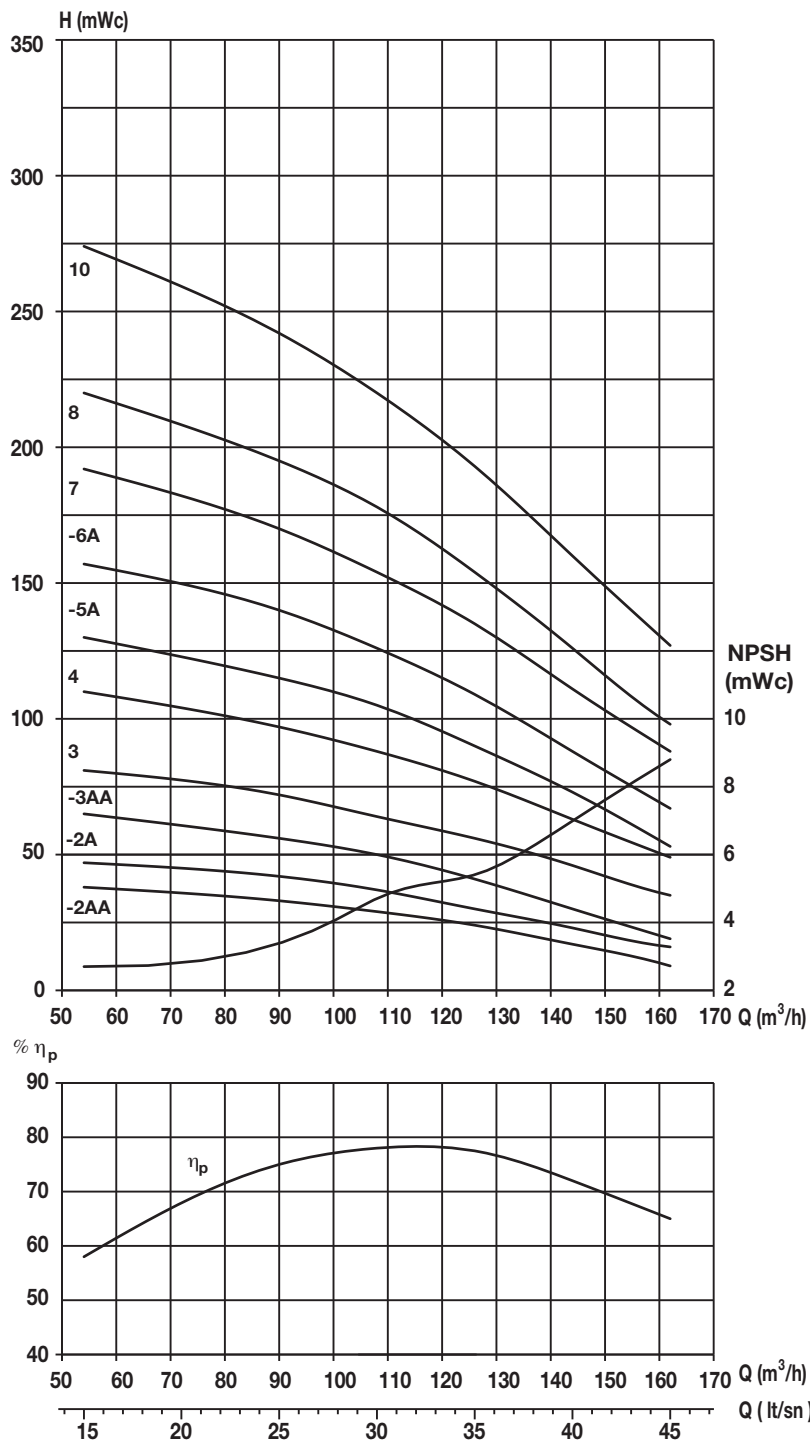



PUMP TYPE	MOTOR TYPE kW/HP	FLOW		(m ³ / h)	54	90	108	126	144	162
				(lt / sn)	15,0	25,0	30,0	35,0	40,0	45,0
		NPSH	(mWc)	2,7	3,4	4,7	5,4	7	8,8	
8125 KPS / 02-AA	ALK 6-13 kW /17.5 HP	⇒		38	33	29	24	17	9	
8125 KPS / 02-A	ALK 6-18.5 kW /25 HP		47	42	37	30	23	16		
8125 KPS / 02	ALK 6-22 kW /30 HP		55	49	43	38	28	17		
8125 KPS / 03-AA	ALK 6-22 kW /30 HP		65	56	50	41	30	19		
8125 KPS / 03	ALK 6-30 kW /40 HP		81	72	64	56	46	35		
8125 KPS / 04	ALK 6-37 kW /50 HP		110	97	88	77	63	49		
8125 KPS /05-A	ALK 8-45 kW /60 HP		130	115	105	90	73	53		
8125 KPS / 05	ALK 8-55 kW /75 HP		138	122	111	98	81	64		
8125 KPS / 06-A	ALK 8-55 kW /75 HP		157	140	126	109	88	67		
8125 KPS / 06	ALK 8-66 kW /90 HP		164	145	132	115	95	75		
8125 KPS / 07	ALK 8-66 kW /90 HP		192	170	154	135	111	88		
8125 KPS / 08	ALK 8-75 kW /100 HP		220	195	178	154	126	98		
8125 KPS / 09	ALK 8-92 kW /125 HP		246	218	198	173	139	102		
8125 KPS / 10	ALK 8-92 kW /125 HP		274	242	220	193	160	127		



8160 KPS

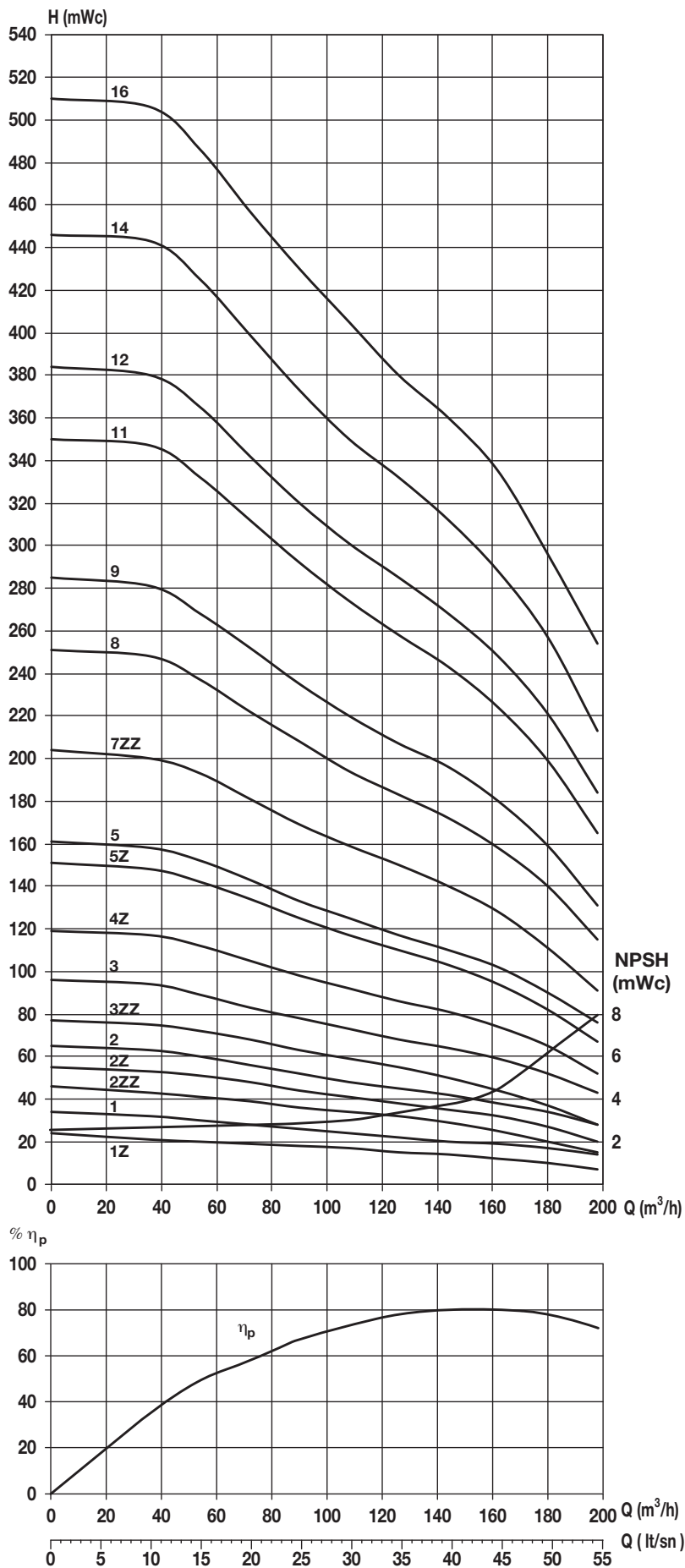



PUMP TYPE	MOTOR TYPE kW/HP	FLOW												
			(m ³ / h)	0	36	54	72	90	108	126	144	162	180	198
			(lt / sn)	0	10	15	20	25	30	35	40	45	50	55
	NPSH	(mWc)	2,6	2,6	2,6	2,8	2,9	3,0	3,4	3,8	4,6	6,3	8,0	
8160 KPS / 1Z	ALK6-9.2kW Y	H (mWc)	⇒	24	21	20	19	18	17	15	14	12	10	7
8160 KPS / 1	ALK6-13kW Y			34	32	30	28	26	24	22	20	19	17	14
8160 KPS / 2ZZ	ALK6-18.5kW Y/Ü			46	43	41	39	36	34	32	29	25	20	15
8160 KPS / 2Z	ALK6-22kW Y/Ü			55	53	51	48	44	41	38	35	32	27	20
8160 KPS / 2	ALK6-26kW Y/Ü			65	63	60	56	52	48	45	42	38	34	28
8160 KPS / 3ZZ	ALK6-30kW Y/Ü			77	75	72	68	63	59	55	50	44	37	28
8160 KPS / 3	ALK8-37 kW Y/Ü			96	94	89	83	78	73	68	64	59	52	43
8160 KPS / 4Z	ALK8-45 kW Y/Ü			119	117	112	105	98	92	86	81	74	65	52
8160 KPS / 5Z	ALK8-55 kW Y/Ü			151	148	142	134	125	117	110	103	94	82	67
8160 KPS / 5	ALK8-66 kW Y/Ü			161	158	152	143	133	125	117	110	102	90	76
8160 KPS / 7ZZ	ALK8-75 kW Y/Ü			204	200	193	181	169	159	150	140	128	111	91
8160 KPS / 8	ALK8-92 kW Y/Ü			251	248	237	222	208	194	183	172	158	140	115
8160 KPS / 9	ALK 10-110 kW Y/Ü			285	281	268	252	235	220	207	196	180	159	131
8160 KPS / 11	ALK 10-129 kW Y/Ü			350	347	332	312	292	274	258	243	224	199	165
8160 KPS / 12	ALK 10-147 kW Y/Ü			384	380	365	342	320	301	285	268	248	221	184
8160 KPS / 14	ALK10-165 kW Y/Ü			446	443	425	399	373	350	332	312	288	257	213
8160 KPS / 16	ALK10-185 kW Y/Ü	510	506	486	457	430	405	380	360	335	296	254		



Maximum
efficiency point

FOR SECURE AND EFFICIENT USES

- Well water temperature and sand ratio in the well water should be controlled in the laboratory. Maximum sand in the well water should be 50 gr/m³ and well temperature should be 30°C.
- Pipes and Pipe clamps should have durability as carrying water in the vertical tube, tube group and itself weight.
- It is recommended that well diameter is bigger than pump diameter as at least 2" (inch).
- Distance between pump suction filter and well filter should be maximum.
- Distance between the bottom end of the motor and base of the well should be at least 50 cm. Length of pump in the well is determined due to this measurement.
- Since pump does not suck air, pump assembly depth should be proper to Net Positive Suction Height (minimum depth it can work at) values.

APPLICATION METHODS

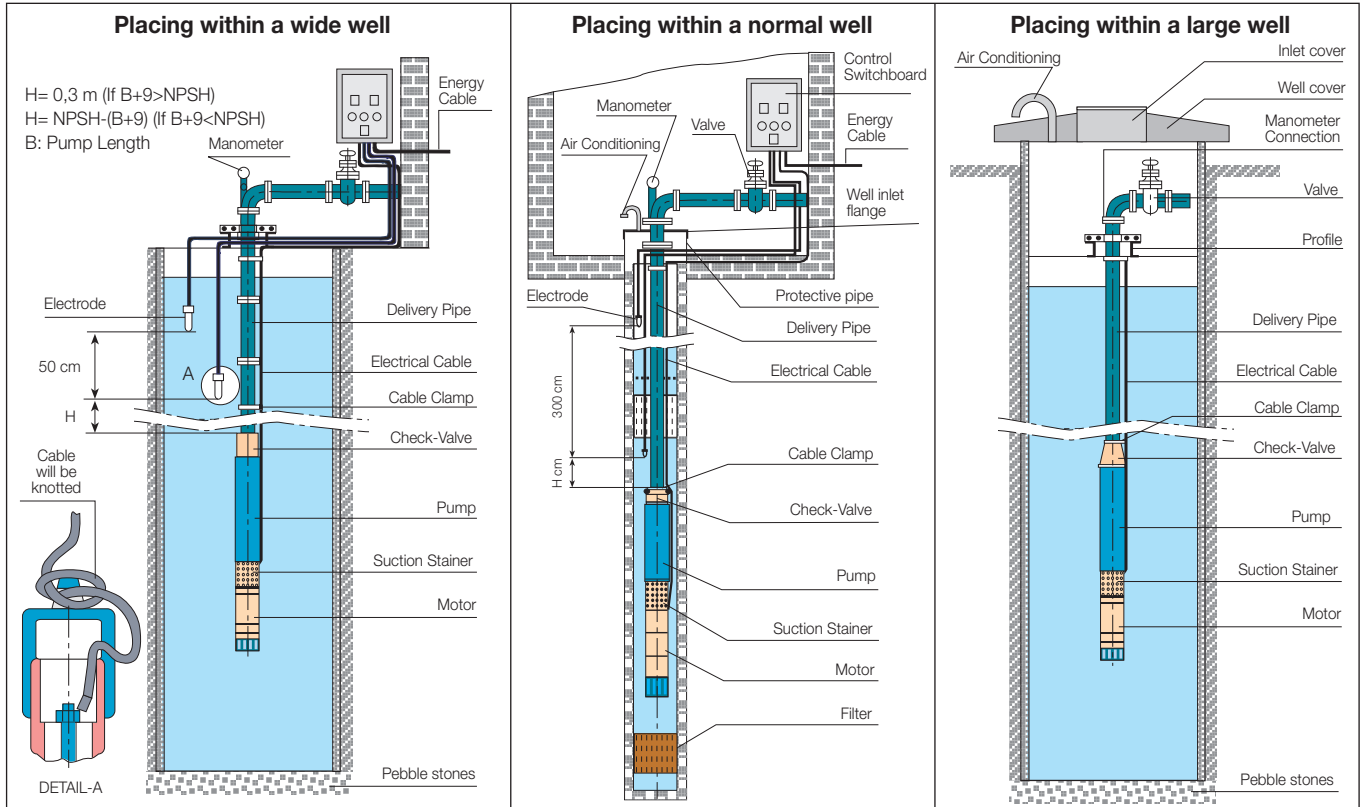

Order Notation

6 046 / 15KPS + AL6 - 30 -T. 60

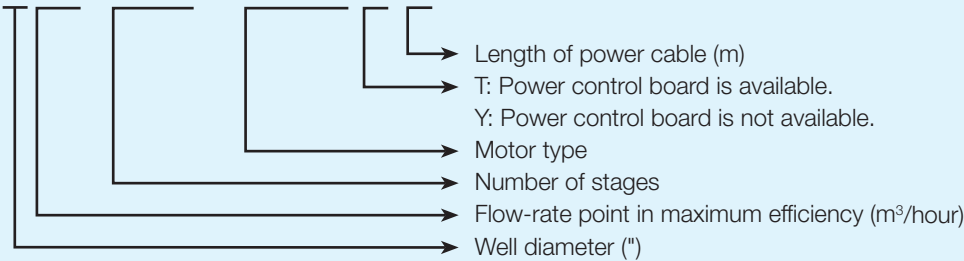

Alarko plunger pumps are shipped from the factory after being packaged safely. The packages of 6" plunger pumps include hexwrench, water filling hopper and locktite. Control board, water level control electrodes and cable are optional. They are delivered in a separate package if ordered.

The right to amend specifications under technologic developments is reserved

ALARKO



**ALARKO CARRIER
SANAYİ VE TİCARET A.Ş.**

GOSB-Gebze Organize Sanayi Bölgesi
Şahabettin Bilgisu Cad. 41480 Gebze-Kocaeli/TURKEY

Phone : (90)(262) 648 60 00 PBX

Telefax : (90)(262) 648 61 01

web : www.alarko-carrier.com.tr

e-mail : info@alarko-carrier.com.tr