

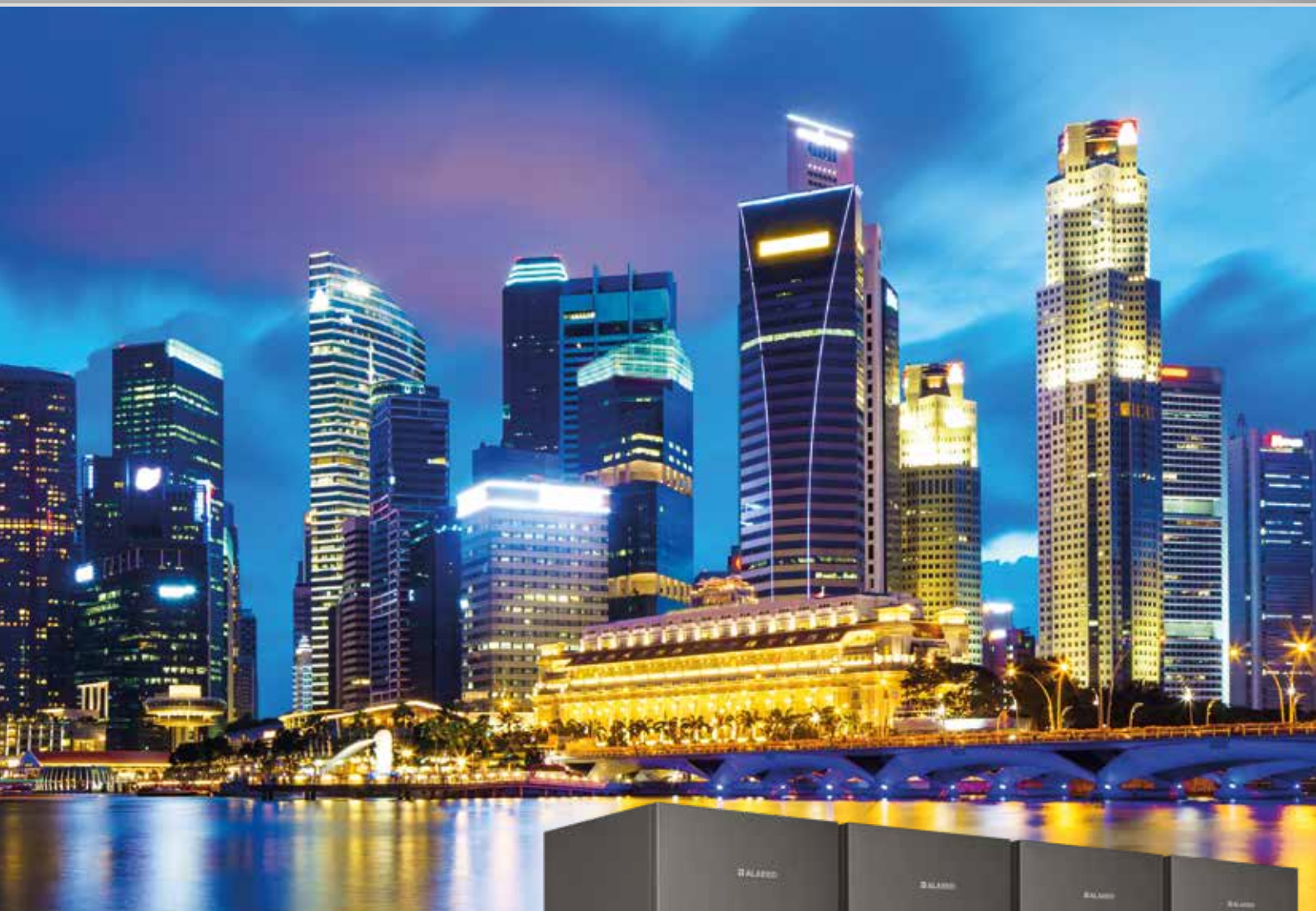

Condensing Boiler Aldens W Series



67 - 90 - 110 - 131 - 154 kW



aldens

LOW EMISSION RATE
**ECO-FRIENDLY
BOILER**

ALARKO



Wall Mounted Premix Condensing Boiler

Elegant and Modern Design

- With its aesthetics and renewed modern color, the new Aldens W series boiler adds value to your apartment.
- Small space occupancy in boiler room with very small dimensions in contrast to their capacities
- A total of 10 types including leading one with control panel and follower with LED dashboard with 5 different capacities
- Patented, specially developed heat exchanger hanger system
- Control card protection box with utility model documentation
- All mains and signal outputs required for ease of connection are transferred behind the front panel with terminals.

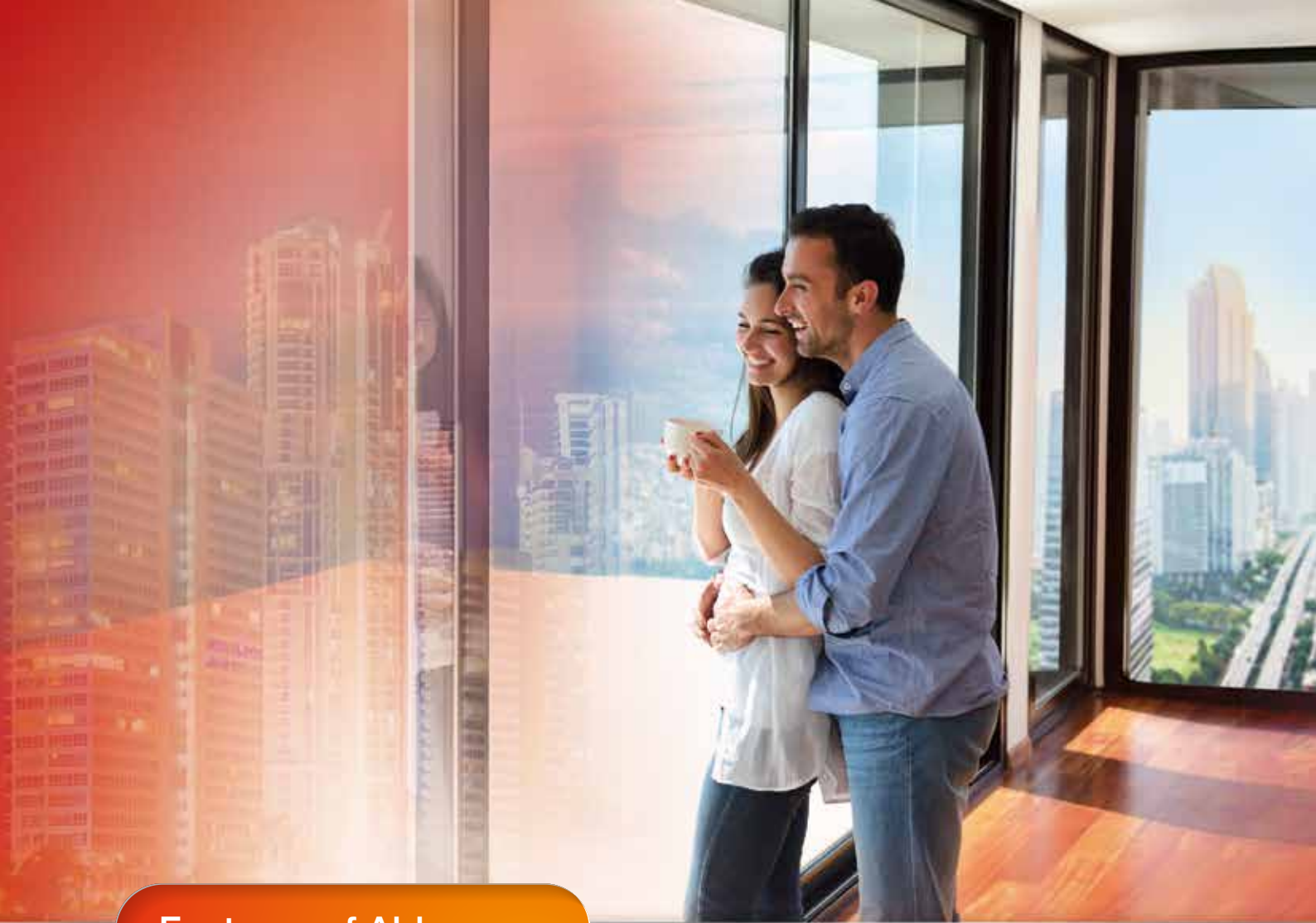

Features of Aldens

- Ideal gas-air blend with premix system, high efficiency, low noise level, low flue gas temperature and low emission rate, environmentally friendly product
- 67, 90, 110, 131, 154 kW capacities (at 50/30°C)
- Large project solutions on the wall with the possibility of cascade reaching up to 2,462 kW in 16 units
- Internal flue gas flap in 85, 105, 130, 150 types,
- If it is 65 type, cascade possibility by using external flue flap
- Minimum stop-and-go, maximum fuel economy (20-100%) with very wide heating modulation range
- Seasonal space heating efficiency within a range of 91-93%
- Low volume intensity in the range of 59-67 dB
- Long-lasting, durable, stainless steel exchanger
- Suitable for natural gas, can be easily converted and operated with Propane LPG
- EMC (Electromagnetic Compatibility) and LVD (Low Voltage Directive) compliant
- 4.5 bar maximum operating pressure on model 65 and 6 bar on other models
- 4.5 bar safety valve in 65 model, 6 bar safety valve in other models and expansion tank connection piece are supplied together
- Very high quality and durability with Siemens electronic board, Sermeta stainless steel exchanger
- According to EN 15502 standard (central heating boilers burning gas with rated heat load not exceeding 1,000 kW)

For All Requirements Fast and Quality Response

Cascade and expansion modules that may be required as accessories according to the installation need are of very small size and are mounted in their specified spaces in the boiler. Different issues such as fixing to the wall or electrical panel of boiler room and long wiring problems are eliminated that is required in the modules mounted on the boiler room wall.

Affordable, wide range of accessories (control module and sensors, chimney and chimney accessories, high energy class pumps, pump connection sets, neutralizers, and suspension console set)

Connection system for ease of service and quick installation

Ease of service with easy and fast module connections, quick heat exchanger maintenance without draining the installation water

Widespread service network... Competitive rates...

Cost-effective spare parts...

CASCADE
Possibility up to
2462
kW



Very High Performance With Cascade System



Instead of using a single large boiler in high-capacity central heating systems such as building blocks and residential sites, operating multiple boilers together in harmony is called the "cascade system".

Cascade modules control the cascade system and communicates constantly with the electronic card in the boilers.

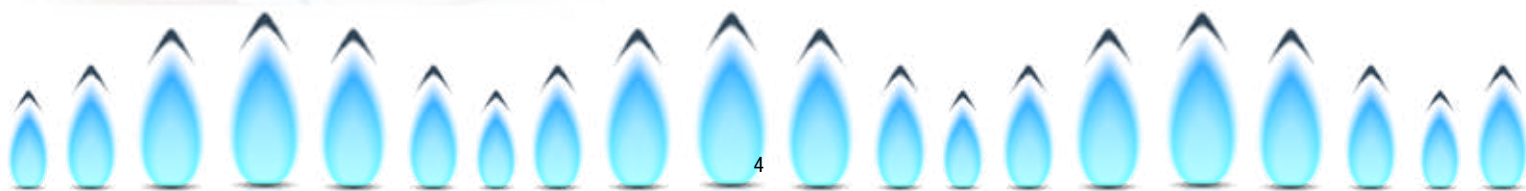



CASCADE WORK SYSTEM

- Up to 16 identical aging cascade boiler connection possibilities.
- In the cascade system, the 1st boiler (leading boiler) is activated in the first place with its leadership duty when there is a need for heat. At the end of the specified period, it transfers the leadership task to the 2nd boiler. In this way, the boilers operate equally for many years
- In cascade operation, the lowest system modulation rate and thereby the highest efficiency is achieved by the activation of a large number of boilers with the early entry, late exit-system.
- Even if one or more boilers malfunction, the other boilers continue to operate and the heating system continues to operate continuously.
- If desired, all boilers can also be installed from leading boilers with a control panel, but since a single screen is enough to program the system, at least one leading boiler can be used to select the follower type with LED indicator panel for all other boilers. This is also an economical solution in terms of initial investment cost

It is important to control air and gas separately with a good electronic detection and control system for obtaining adequate combustion, namely full modulation from a boiler according to the current heat requirement of the housing.

With modulation:

- Stop-start operation of the boiler is prevented,
- Heating comfort is increased,
- System losses are minimized,
- Emissions of harmful substances during ignition are reduced.

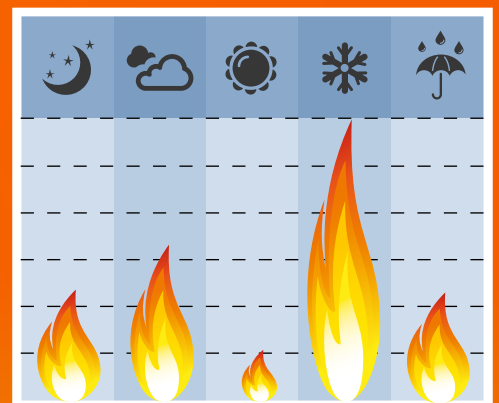

With real modulation, the device can always be operated with the highest efficiency not only in one season, but also in different weather conditions, transition seasons, night and day.

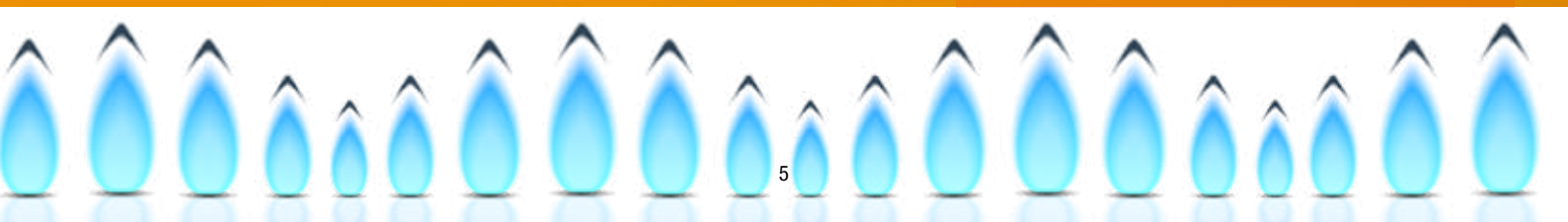



aldens Control Panel

ALDENS W SERIES - WM





aldens  LED Illuminated Briefing

ALDENS W SERIES - WS



Malfunction state
(Red LED flashes)



Initial electrical connection / parameter loading
(Red and blue LED lights up together)



OFF / burner not working
(LED indicator does not light up)



Burner ON
(Blue LED lights continuously)

IMPORTANT COMPONENTS

Aldens condensing boilers consist of high-quality components produced by expert brands in the premium segment which have gained the appreciation of manufacturers, users, and services all over the world. For maximum safety and ideal control, the boilers are equipped with a thermostat and sensors.

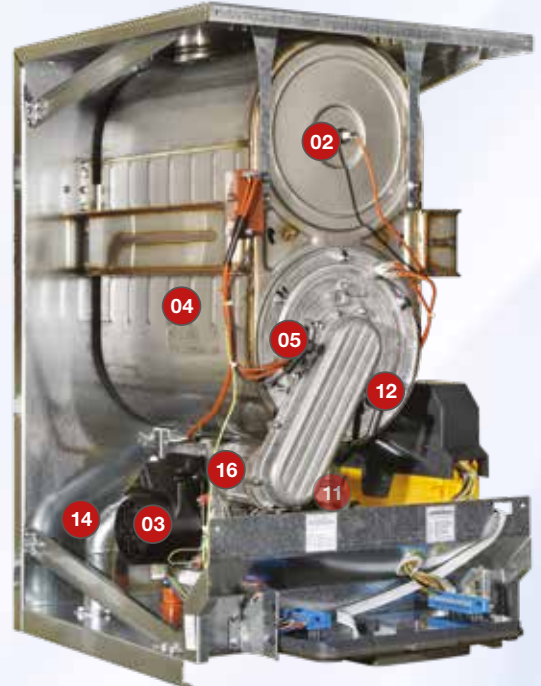

ALDENS WM/WS SERIES - 85/105/130/150

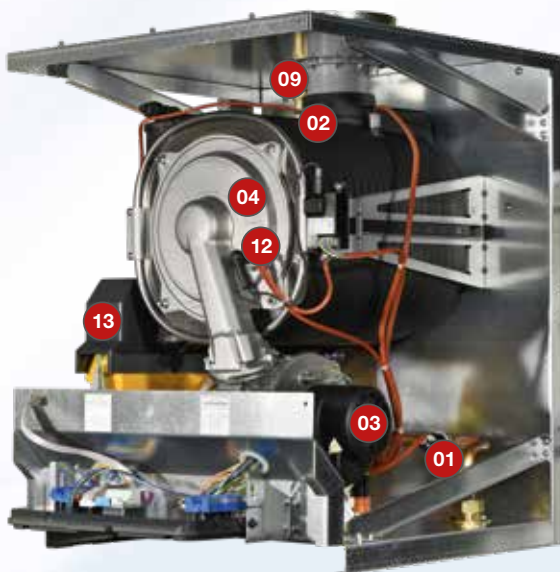

ALDENS WM/WS SERIES - 65

- 01** Pressure Sensor
- 02** Flue Gas Temperature Sensor
- 03** Fan
- 04** Exchanger
- 05** Ignition Electrode
- 06** Boiler Return Pipe
- 07** Boiler Depart Pipe
- 08** Boiler Return Temperature Sensor
- 09** Automatic Air Release Purge 1/2"
- 10** Gas Valve
- 11** Venturi
- 12** Ignition and Ionization Electrode
- 13** Mainboard Protection Box
- 14** Condensate Siphon and Drain Hose
- 15** Boiler Depart Temperature Sensor
- 16** Flap for Flue Gas Backflow Inhibitor (Models 85,105,130,150)

EXCHANGER (Heat Exchanger)

Quiet, Long-lasting and Environmentally Friendly

- **Sermeta** branded exchanger with low CO footprint 100%
- Made of cylindrical, smooth, long-lasting stainless steel.
- Highly efficient, robust, resistant to thermal shocks.
- Four different types of heat exchangers are used for types 65, 85, 105, 130 and 150.
- Developed by Sermeta, the burner of the exchanger is a patented, very quiet and long-lasting Bluejet® burner.
- Quick maintenance is performed by removing only a few nuts and easily reaching the combustion cell.



Operation Diagram

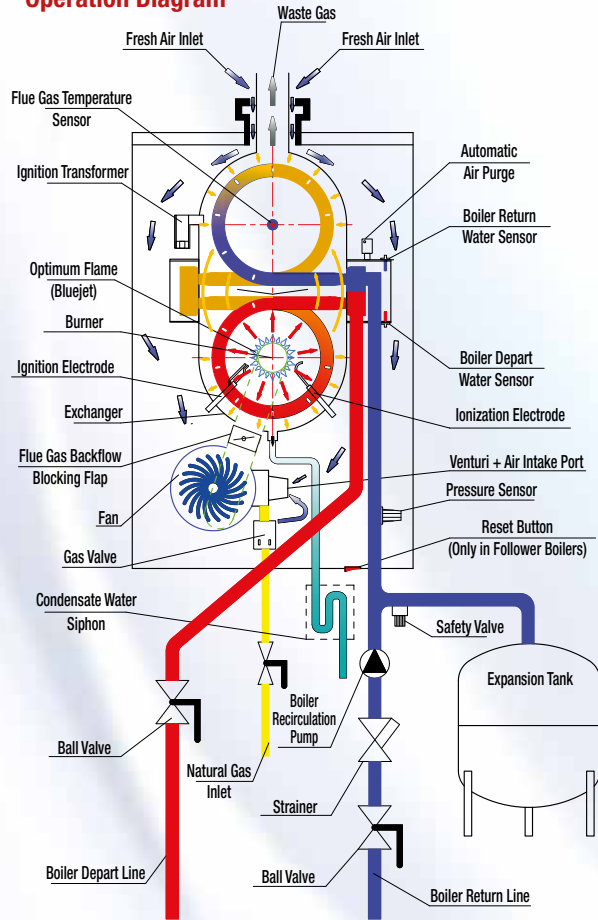

MAIN CARD



- The newest **Siemens** brand LMS14 card is used.
- Control of heating, domestic water, and solar energy applications
- Protection of the heat exchanger from thermal stresses with the excessive ΔT (delta T) prevention system
- Parameter loading with parameter stick (microcircuit board)
- Heating, boiler, and external relay time program
- Additional circuit control with 3 expansion module connection possibilities
- 1x 230 V energy outlet
- 3x 230 V relay outputs: Assigned as stepped boiler pump, direct circuit pump, and boiler pump
- (1 separation on/off three-way valve can be connected)
- Modulated pump control with 1 PWM (pulse width modulation) connection
- 4 empty sensor connections (outdoor air, cascade, and boiler sensors assigned, one not assigned)
- 3 digital inputs (e.g. with 3 room thermostat connections, on/off control of 3 separate heating circuits, or swimming pool control)
- Comfort/economy position and boiler water temperature change of 2 separate heating circuits with 2 indoor unit connections

FAN- VENTURI GROUP, GAS VALVE, and FLUE GAS FLAP



The required amount of air-gas blend is provided depending on the boiler capacity with the **EBM** brand modulated fan. The fan speed increases or decreases depending on the capacity. Thus, both low noise level is maintained and low efficiency due to excess air is not in question.

With **Honeywell** brand venturi, the ideal air-gas blend ratio of 1:10 is ensured to be constant throughout the entire capacity range. This is the most important factor that ensures efficiency and a clean combustion.

The **Honeywell** brand gas valve safely provides the gas flow required for combustion, depending on the varying speed of the modulated fan according to capacity.

The flue gas flap, which is mandatory for use in positive pressure cascade systems, is located internally in the appliance on 85/105/130/150 models.

High Security FULL CONTROL

CONTROL MODULE, SENSORS AND TOOLS



OCI345.06/101 Cascade Module

Cascade systems must be located in each boiler in the system for multiple boiler control. It is factory-mounted to follower boilers (WS).

Therefore, only 1 per cascade is required for the leading (WM) boiler to be used only in the cascade system.



AGU2,550x109 Expansion Module

Used for 1 blend circuit check (3-way blend valve + pump + flow sensor) check or 3 direct circuit pump feeds. There is an additional 1 sensor output (for solar collector sensor or swimming pool sensor, etc.). 3 expansion modules can be installed in each boiler.



QAC34/101 Outdoor Air Sensor

Used to operate the boilers according to outdoor weather conditions. Mandatory to use one in each cascade system.



QAZ36.522/109 Immersion Type Sensor

Used as a boiler sensor, balance vessel sensor, etc.

QAZ36.481/101 Immersion Type Sensor

Used as a solar collector sensor. It can measure up to 200°C.

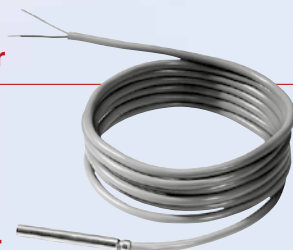

CONTROL MODULE, SENSORS AND TOOLS

QAD36/101 Clamp Type Sensor

It is used for depart and return water sensors. If the plate exchanger is used as the primary-secondary circuit separator, it is placed in the exit after the exchanger.



QAA55.110/101 Indoor Room Unit

Used for zone control (direct circuit or blend circuit). Comfort /economy position change, boiler water temperature increase/decrease can be done. 2 indoor room units can be connected to each boiler.



RAA 21 Room Thermostat

Used for zone control. Operates the boiler according to the set temperature (in the direct circuit or blend circuit). There are a total of 3 room thermostat connections in each boiler.



OZW672 Web Server

System control, monitoring and settings can be made by accessing single boiler or cascade systems via remote web server via computer or smart phone. There are types that can control 1 device, up to 4 devices and up to 16 devices (OZW672.01/04/16).

Error message and periodic report are sent by e-mail to up to 4 users registered in the system. The menu is in English.



OCI351.01/109 Modbus Communication Module:

Modbus is used for communication with the building management system. For communication, it is sufficient to connect only one module to the leading boiler. If the values of all boilers need to be seen separately, one should be installed in each boiler.



aldens 

Reachable and
Eco-Friendly
Quality



Boiler Recirculation Pumps

High energy class PWM connected (modulated) or fixed pressure/variable pressure adjustable pumps with EEI (Energy Efficiency Index) X 0.23 selected according to the use of balance vessel or plate heat exchanger are offered as accessories with Aldens boiler.

Pump Connection Sets

Connection sets have been prepared for easy assembly of pumps to Aldens boilers. It has three different diameters for 65, 85/105 and 130/150 types.

Neutralizers



The use of a neutralizer that neutralizes acidic condensation water is mandatory for installations of 200 kW and above. In natural gas, the pH before neutralization is 3.5-4 and after neutralization is between 6-7. There are three models.
Neutrakon® 03/150 for < 150 kW
Neutrakon® 04/BGN with auxiliary pump for < 300 kW and
Neutrakon® 08/BGN with auxiliary pump for < 650 kW

Fresh Air Suction Grill

In cases where the fresh air required for combustion is taken from the boiler room, it is attached to each boiler in order to prevent the entry of live animals or foreign substances such as paper, cloth, etc.



ACCESSORIES

External Flue Gas Flue Flap

It is used externally in positive pressure cascade chimney systems of 65 type accidents.



Safety Valve

The safety valve, which is mandatory to be used in each boiler, is provided free of charge in each boiler package as 4.5 bar in 65 type and 6 bar safety valve in 85/105/130/150 type. The expansion tank opening on it provides an advantage in additional accessory cost and workmanship.



Hanger Console Set

It is used in cases where the wall of the boiler room cannot support the weight of the boilers or where the boilers must be hung with front to back to save space. It is modular, can be reproduced back-to-back and side-to-side. It is made of durable rectangular profiles made of material complying with DIN 59411 standard. RAL9006 is gray. It has lugs to be fixed to both the floor and the wall on which it will be leaned.

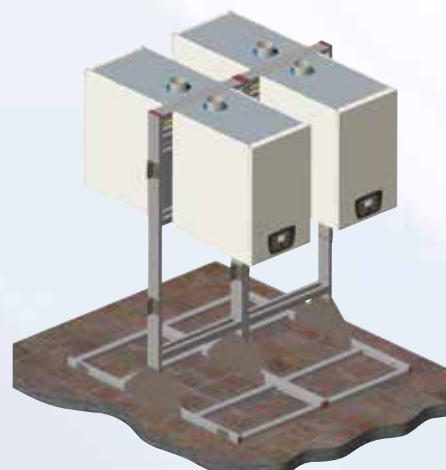

INSTALLATION DIAGRAM SAMPLES



Outside Air Sensor

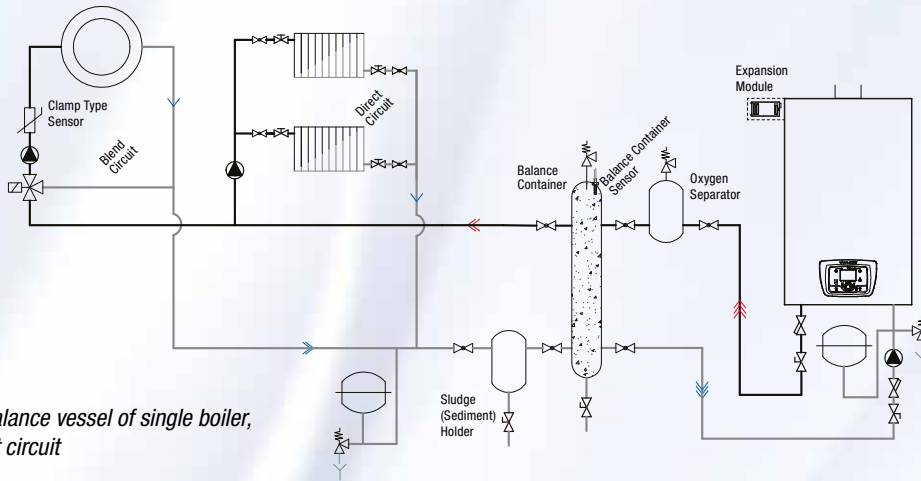

Installation diagram with balance vessel of single boiler, 1 blend circuit, and 1 direct circuit



Outside Air Sensor

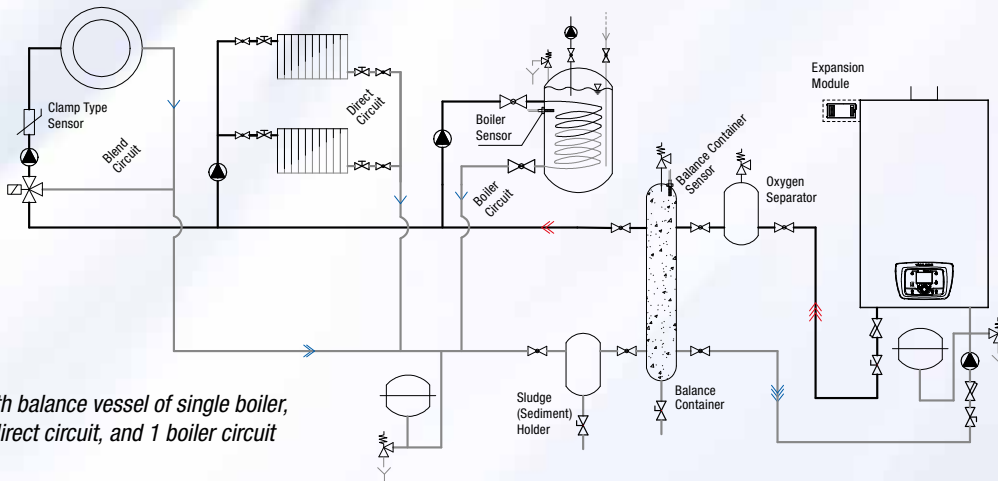

Wiring diagram with balance vessel of single boiler, 1 blend circuit, 1 direct circuit, and 1 boiler circuit



Outside Air Sensor

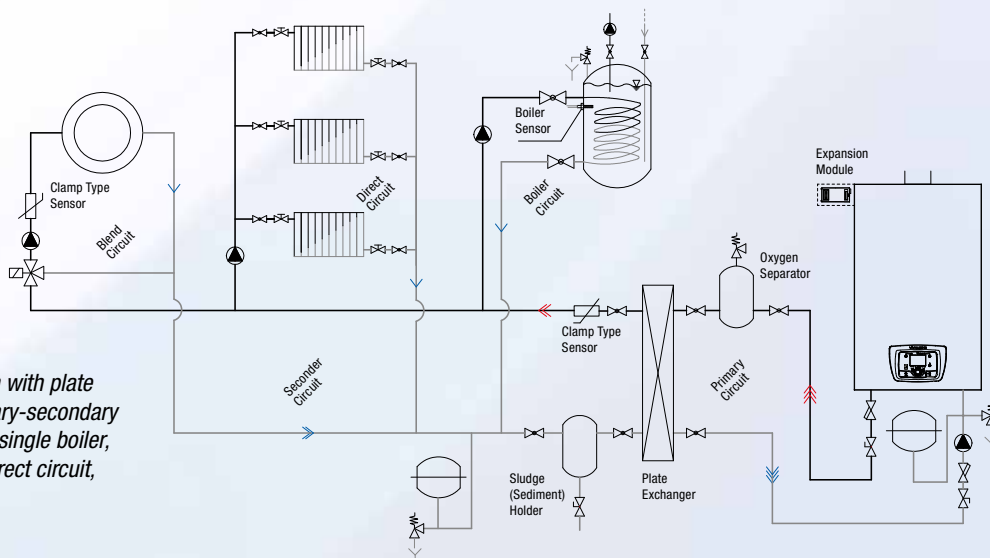

Installation diagram with plate exchanger as primary-secondary circuit separator of single boiler, 1 blend circuit, 1 direct circuit, and 1 boiler circuit

INSTALLATION DIAGRAM SAMPLES

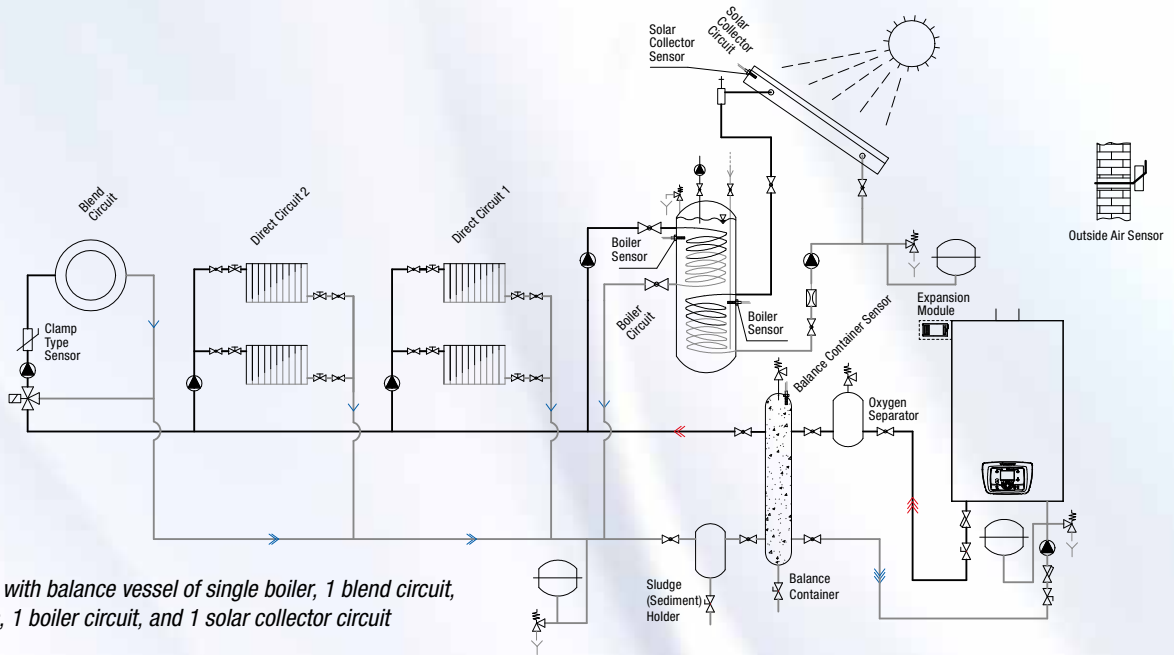

Wiring diagram with balance vessel of single boiler, 1 blend circuit, 2 direct circuits, 1 boiler circuit, and 1 solar collector circuit

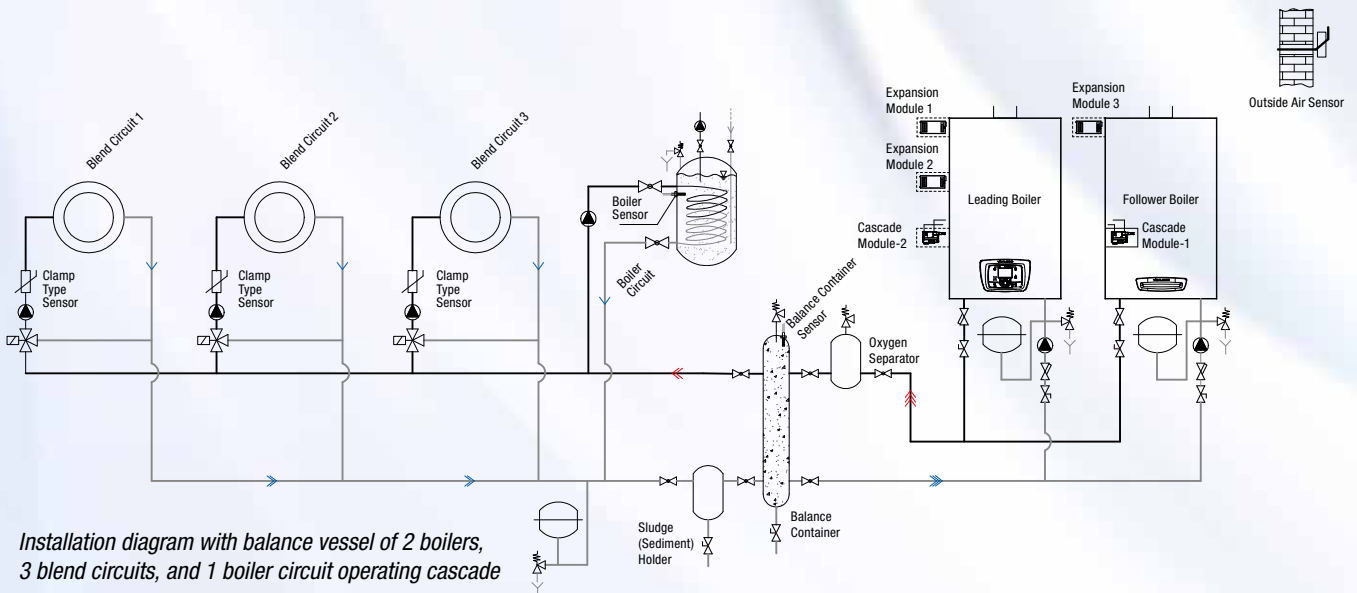

Installation diagram with balance vessel of 2 boilers, 3 blend circuits, and 1 boiler circuit operating cascade

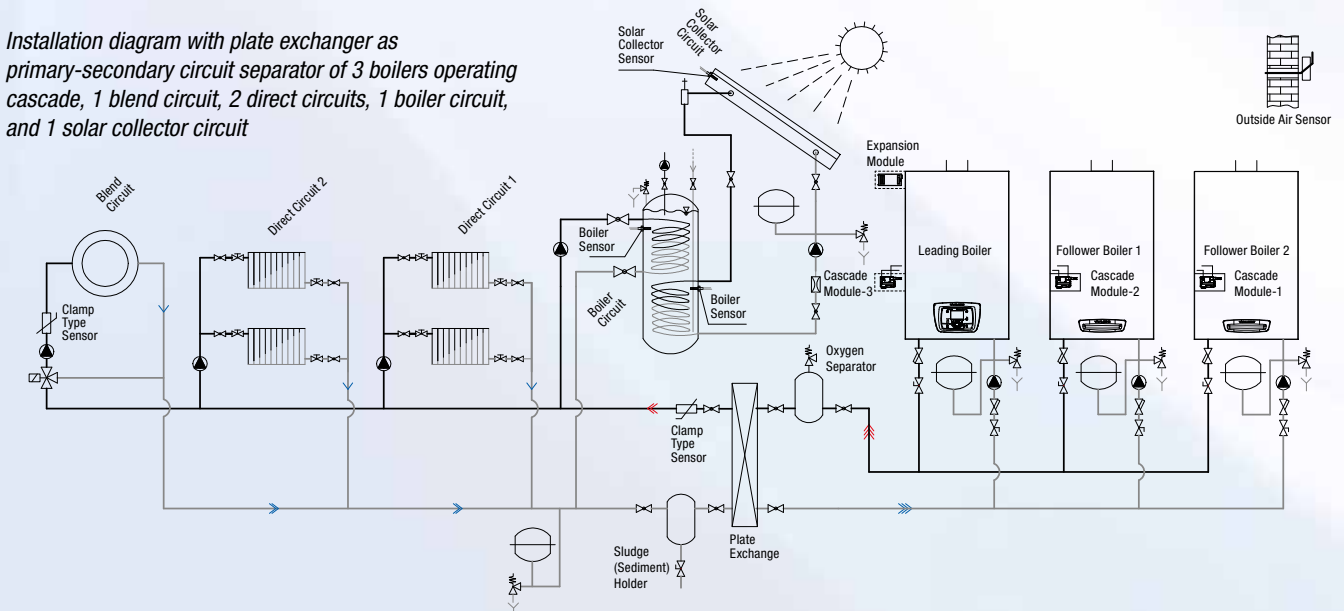

Installation diagram with plate exchanger as primary-secondary circuit separator of 3 boilers operating cascade, 1 blend circuit, 2 direct circuits, 1 boiler circuit, and 1 solar collector circuit

Dimensions



Bottom View

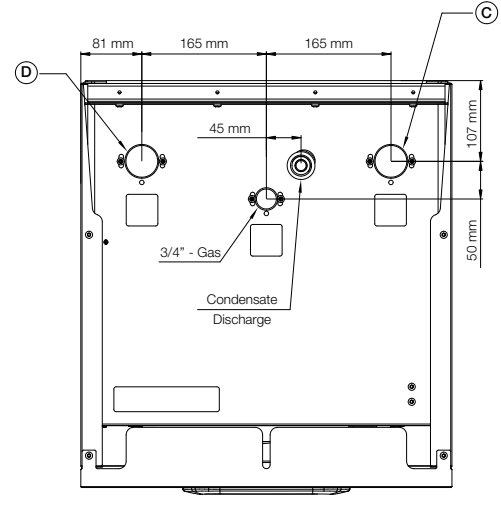

*WS type boilers have the same dimensions with WM type boilers.

TECHNICAL FEATURES	UNIT	ALDENS WM/WS				
		65	85	105	130	150
Heating Technical Specifications						
Seasonal Location Heating Energy Efficiency Class		No energy class above 70 kW is determined				
Seasonal Space Heating Energy Efficiency ($\eta_{s,h}$)	%	91	93	93	93	92
Efficiency at 30% Partial Load ($\eta_{p,30}$) (50-30°C)	%	97.7	98.1	98.3	97.6	96.7
Efficiency at Maximum Capacity (η_{d}) (80-60°C)	%	87.3	86.8	86.6	87.6	87.4
Rated Heat Power (P_{rated}) (80-60°C)	kW	65	86	106	128	148
Maximum Heating Capacity (P_d) (80-60°C)	kW	61.6	81.9	101	121.6	140.7
Minimum Heating Capacity (80-60°C)	kW	12	16.6	20.3	25.5	28.3
Maximum Heating Capacity (50-30°C)	kW	67.2	89.8	109.7	130.8	153.9
Heating Capacity at 30% Partial Load ($P_{p,30}$) (50-30°C)	kW	20.7	27.8	34.4	40.6	46.7
Minimum Heating Capacity (50-30°C)	kW	13.4	18.3	22.9	27.9	30.7
Auxiliary Electricity Consumption at Full Load ($e_{l,max}$) (80-60°C)	W	92	105	129	207	279
Auxiliary Electricity Consumption at Partial Load ($e_{l,min}$) (80-60°C)	W	17	20	23	27	29
Discharge Water Temperature Adjustment Range (Min. - Max.)	°C	8 - 95 (fabrication 80)				
Heating Working Pressure (Min. - Max.)	bar	1 - 4.5		1 - 6		
General Technical Specifications						
NOx Class		6				
Nitrogen Emission (NO_x)	mg/kWh	44.2	46.2	41.3	55.2	54.6
Sound Power Level, Indoor (L_{WA})	dB	58.8	61.9	63.8	66.3	67.4
In Standby State		3				
Auxiliary Electricity Consumption (P_{SB})	W	3				
Heat Loss During Standby (P_{stby})	kW	0.068	0.08	0.08	0.117	0.121
Ignition Burner Energy Consumption (P_{ign})	kW	1.75	2.92	1.966	1.94	2.16
Flue Gas Temperature (50-30°C, Min. - Max.)	°C	40.4 - 63.3	37.7 - 47.9	33.4 - 60.4	34.1 - 55.4	38.7 - 57.8
Flue Gas Temperature (80-60°C, Min. - Max.)	°C	64.1 - 82.7	60.7 - 72.6	59.7 - 80.3	61.7 - 79.7	62 - 75.6
Natural Gas Consumption (50/30°C Min. - Max.)	m³/h	1.35 - 6.87	1.83 - 8.81	2.31 - 11.14	2.77 - 12.96	3.12 - 14.78
Natural Gas Consumption (80/60°C Min. - Max.)	m³/h	1.34 - 6.84	1.81 - 8.62	2.17 - 10.94	2.72 - 12.81	3.01 - 14.64
LPG Consumption (50/30°C Max. - 80/60°C Max.)	kg/h	4.18 - 4.11	5.22 - 5.17	6.59 - 6.59	7.70 - 7.81	9.02 - 9.07
Maximum Electricity Consumption	W	92	107	132	206	287
Physical Properties						
Flue Connection Types		B23-B33-C13x-C33x-C43x-C53-C53x-C83x-C93x				
Internal Flue Gas Flap		No	Yes	Yes	Yes	Yes
Flue Connection Diameter (Flue Gas/Fresh Air) Max. Linear Length		Ø100/150 - 26	Ø100/150 - 25.1	Ø100/150 - 17.5	Ø100/150 - 11.2	Ø100/150 - 9
Flue Connection Diameter (Waste Gas + Fresh Air - Max. Linear Length)	mm - m	Ø80 - 17 Ø100 - 77 Ø130 - 325	Ø80 - 7 Ø100 - 75 Ø130 - 317	Ø80 - 3 Ø100 - 52 Ø130 - 226	Ø100 - 32 Ø130 - 151	Ø80 - 1 Ø100 - 26 Ø130 - 125
Cascade Flue Connection Diameter - Max. Length		It should be calculated by authorized chimney companies for the project.				
Size (Width x Height x Depth)	mm	493 x 627 x 540	493 x 797 x 540			493 x 797 x 635
Weight (Empty - Full)	kg	54.6 - 58	68.7 - 75.3		75.2 - 83.4	88.6 - 98.7
Heater Depart - Return Diameter (D - C)	inch	1"				
Gas Inlet Diameter	inch	3/4"				
Gas Inlet Pressure (Natural Gas-LPG)	mbar	20 - 30				
Power Source	V/Hz	230/50				
CE Certificate	No	1312CQ6111				



Manufacturer reserves the right to change any product specifications without notice.



GOSB-Gebze Organize Sanayi Bölgesi
 Şahabettin Bilgisu Cad. 41480 Gebze-Kocaeli/TURKEY
Phone : (90)(262) 648 60 00 PBX
Telefax : (90)(262) 648 61 01
web : www.alarko-carrier.com.tr
e-mail : info@alarko-carrier.com.tr

