

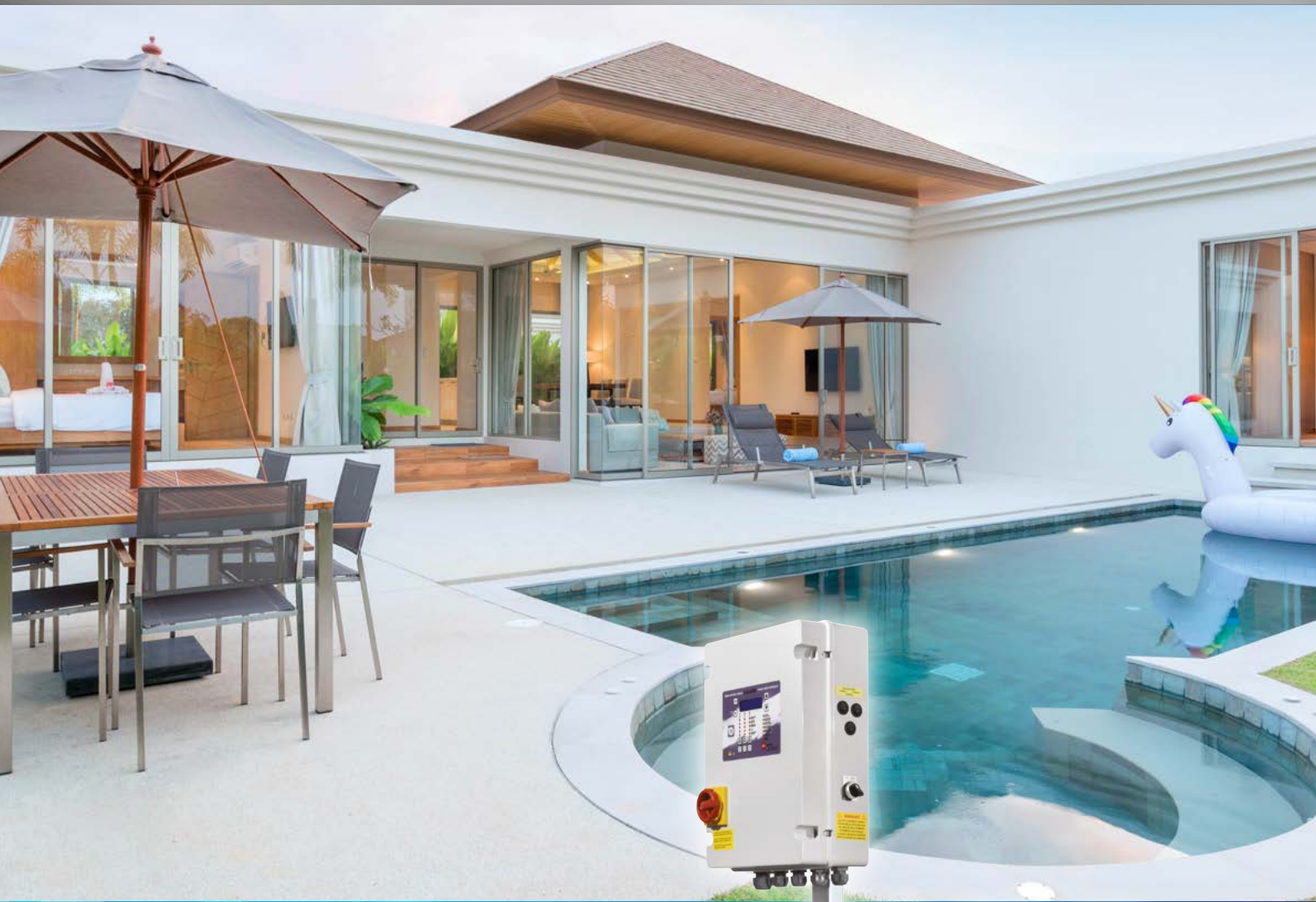

ALDH & ALDHF 2/4 Series Water Boosters



SA8000
BUREAU VERITAS
Certification



Alarko ALDH & ALDHF 2/4 Water Boosters

Standard ALDH Series

Alarko Carrier raises the quality standard it offers to its users with the developments and innovations it has made in ALDH water boosters it produces with its nearly half a century of experience.

With specially designed, compact and reliable water boosters, Alarko Carrier offers economical and reliable solutions for keeping drinking, tap, process, and irrigation waters at a continuous and desired level.

Apart from the three-phase types of standard ALDH series water boosters pumps, there are also 6 models with mono-phase motors that can be operated on the mains at ~1, 220 V, 50Hz.

ALDHF Series with Frequency Inverter

It has been developed to maximize energy savings and provide the highest comfort. Boosters with variable-frequency drive (VDF) system that reduces pump speed according to decreasing flow or pressure requirement have a high efficiency and unique protection with an internal inverter.



**For villas,
apartment blocks,
and housing
estates**



**For hospitals,
schools, and
business centers**



**For hotels,
social facilities,
and resorts**



**For greenhouses
and farms**



Reliable Hi-Tech

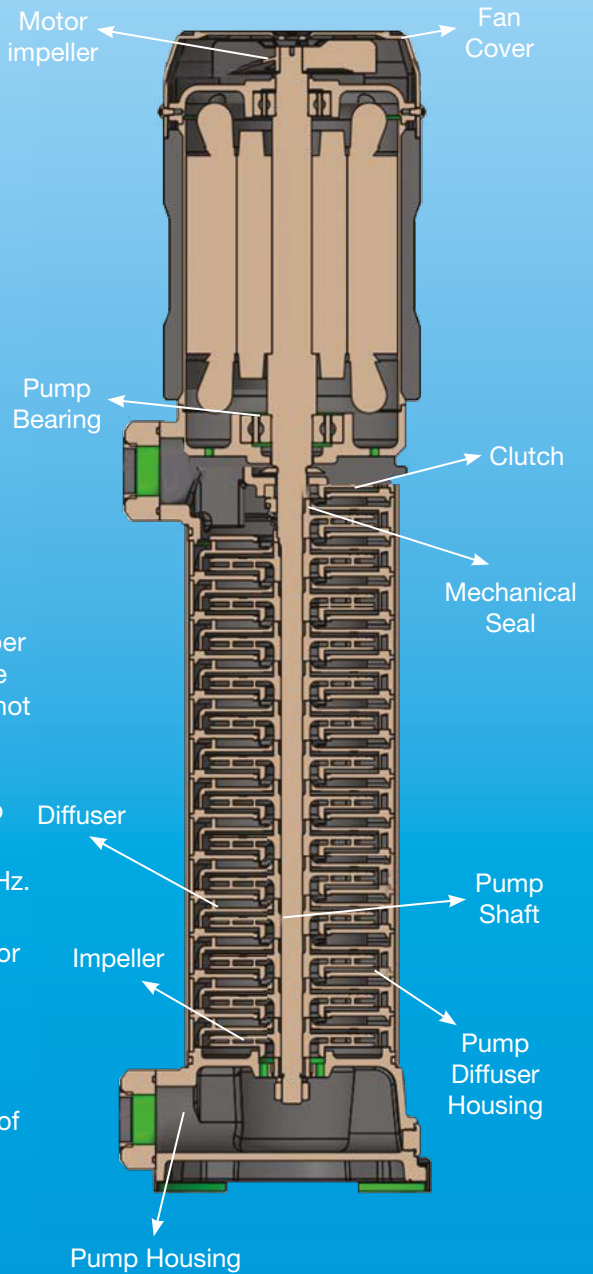

- 1. EXPANSION TANK:** Reservoirs of pressurized water reduce the number of pumps activation and deactivation. Prevents shock and vibration in the installation. It is completely hygienic, does not cause smell in water. It is not included in the standard booster pump set, it is provided separately.
- 2. PUMPING COLLECTOR:** Galvanized. The check valve at the pump outlet prevents the water supplied to the installation from coming back to the pump by pressurization. It also has pressurestats and a manometer.
- 3. MOTOR:** Special design for vertical working conditions. 3~,380 V, 50 Hz.
- 4. CONTROL PANEL:** Advanced, smart, electronic control management system in multi-pump Alarko booster pumps. Thermal protected contactor and controller panel with on-off switch in single-pump booster pumps.
- 5. FLEXIBLE HOSE:** It provides water connection between the pump group and the expansion tank. Galvanized or plastic pipe can be used. However, the flexible hose is very easy to assemble and does not require any special expertise. It's durable. It provides flexibility in the placement of the tank. It is provided separately.
- 6. SUCTION COLLECTOR:** Galvanized. The booster pumps with double and triple pump have ball valves at each pump inlet. Thus, if one of the motopumps malfunctions, the motopump in good condition continues to supply water to the system, the faulty one can be removed and repaired.
- 7. PEDESTAL:** Galvanized. It can be easily fixed to the floor. Prevents vibration and noise.
- 8. LEVEL FLOATER:** Prevents the booster pump from operating when the tank runs out of water. When the tank is full, the booster pump continues to operate automatically.
- 9. NORYL IMPELLER FAN AND DIFFUSER:**



10. LOWER/UPPER BEARING HOUSING OF THE PUMP:



PUMP PART NAME	PUMP MATERIAL
Suction-Pumping Housing	GG20, Cathopheresis Coating
Pump Housing	Stainless, X2CrNi1911/X2CrNiMo17122
Pump Shaft	Stainless, X46Cr13
Impeller	30% Glass Fiber Reinforced PPO
Diffuser	30% Glass Fiber Reinforced PPO+AISI304 Bracelet
Mechanical Seal	Ceramic / Carbon
Rotor	AISI304+45# Kaynak Mili

New Generation Smart Electronic Control Management

In water boosters with double and triple pump, the electronic microprocessor control management system, which regulates and controls all operating functions of the water booster, ensures safe and economical use. The control management system, which is collected in a compact interior and exterior panel, is delivered as mounted on the water booster and all connections are made.

- Low-high current limit values for number of adjustable switches
- Lower risk of water hammer impact with adjustable start and stop time
- Silent operation
- Fewer space requirements for installation
- High security and comfort
 - EIS: Engine Identification System
 - EASR: Equal Aging System by Rotation (On/Off pumps)
 - LCP : Digital - Touch Control Panel
 - MMS: Manual Mode Switching (Manual operation in card failure)
 - HPPS: High Pressure Protection system (in case of sudden pressure rises)
 - Pmin: System blockage in sudden pressure falls. Control over current.
 - Turkish software



Dehydrated Operation Protection:

The water level in the feed water tank is continuously controlled with the floater cutout.

The electronic management system prevents the pumps from running if there is no water in the tank.

Motor Phase Protection:

The electronic management system prevents the engine from falling into two phases during start-up and operation. If the phase is disconnected, it stops the engine.

Phase Order Control:

The electronic management system checks that the phase connections of each motor are in the correct order. Prevents the pumps from turning over at the start-up.

Fire Mode:

The feature to perform tests on the day and time determined by the user.

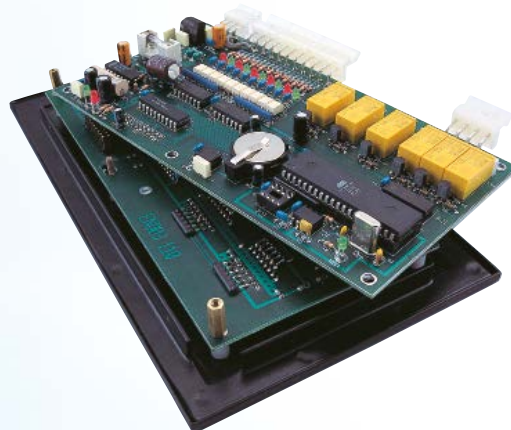

Previous Alarms:

Monitoring 64 recent fault logs.
False Pressure Signal

Protection:

The electronic management system prevents sudden fluctuations in water pressure from causing the pumps to stop and start.

Overcurrent Control:

The electronic management system cuts off the power and protects the engine from burnout if the motor takes overcurrent.

Sequential Automatic Operation:

The electronic management system allows the pumps to be activated in a sequence controlled manner to keep the set plant pressure and the desired water flow constant, and to be switched off as the usage decreases.

- The pump, which is first activated, changes automatically every time it is used.
- Thus, the service life of the motors and pumps will be equal.

Frequency Inverter Panel



* The panel varies according to the number of pumps.
The above panel belongs to two-pump booster pumps.

- 1 Current operating mode of the booster (manual / automatic), total operating time of each pump, running and stopping pumps, type of failure if any (reverse rotation, phase protection, overcurrent, waterless operation) etc
- 2 Switch to manual mode / exit button from parameter display and LED
- 3 Switch to automatic mode and LED
- 4 Changing parameter values
- 5 Entering the parameter display and navigating through the parameters
- 6 Pump running LEDs
- 7 Manual start buttons for pumps
- 8 Pump failure warning LEDs

Technical Specifications

MODEL	Q.max. (m ³ /h)	Q avr. (m ³ /h)	Hmax (m)	Power		Voltage 220/380	Current (A)	Connection Diameters (DN)	KG
				kW	HP				
ALDH 2/7X1 MNF	4	2	65	1.1	1.5	220	7	25/25	29.4
ALDH 2/9X1 MNF	4	2	84	1.5	2.0	220	9.5	25/25	31.7
ALDH 2/7X2 MNF	8	4	65	2x1.1	2x1.5	220	2x7	40/40	63.4
ALDH 2/9X2 MNF	8	4	84	2x1.5	2x2.0	220	2x9.5	40/40	68.4
ALDH 4/6X1 MNF	6	4	58	1.5	2.0	220/380	9.4	25/25	30.9
ALDH 4/6X2 MNF	12	8	58	2x1.5	2x2.0	220/380	2x9.4	40/40	68.4
ALDH 4/6X1 TRF	6	4	58	1.5	2.0	220/380	9.4	25/25	30.9
ALDH 4/6X2 TRF	12	8	58	2x1.5	2x2.0	220/380	2x9.4	40/40	68.4
ALDH 4/6X3 TRF	18	12	58	3x1.5	3x2.0	380	3x9.4	50/50	90.4
ALDH4/8X1 TRF	6	4	77	2.2	3.0	380	4.8	50/50	34
ALDH 4/8X2 TRF	12	8	77	2.2	3.0	380	2x4.8	50/50	74.4
ALDH 4/8X3 TRF	18	12	77	2.2	3.0	380	3x4.8	50/50	93.2
ALDHF 2/7-2 ADVANCE	8	4	65	2x1.1	2x1.5	220	2x7	40x40	78.4
ALDHF 2/9-2 ADVANCE	8	4	84	2x1.5	2x2.0	220	2x9.5	40x40	83.4
ALDHF 4/6-2 ADVANCE	12	8	58	2x1.5	2x2.0	220	2x9.5	40x40	83.4
ALDHF 4/8-2 ADVANCE	12	8	77	2x2.2	2x3.0	220	2x14	50x50	89
ALDHF 4/6-3 ADVANCE	18	12	58	3x1.5	3x2.0	220	3x9.5	50x50	105.4
ALDHF 4/8-3 ADVANCE	18	12	77	2x2.2	2x3.0	220	2x14	50x50	108.2

ALDH & ALDHF 2/4 Series Pump Curves

General Curves

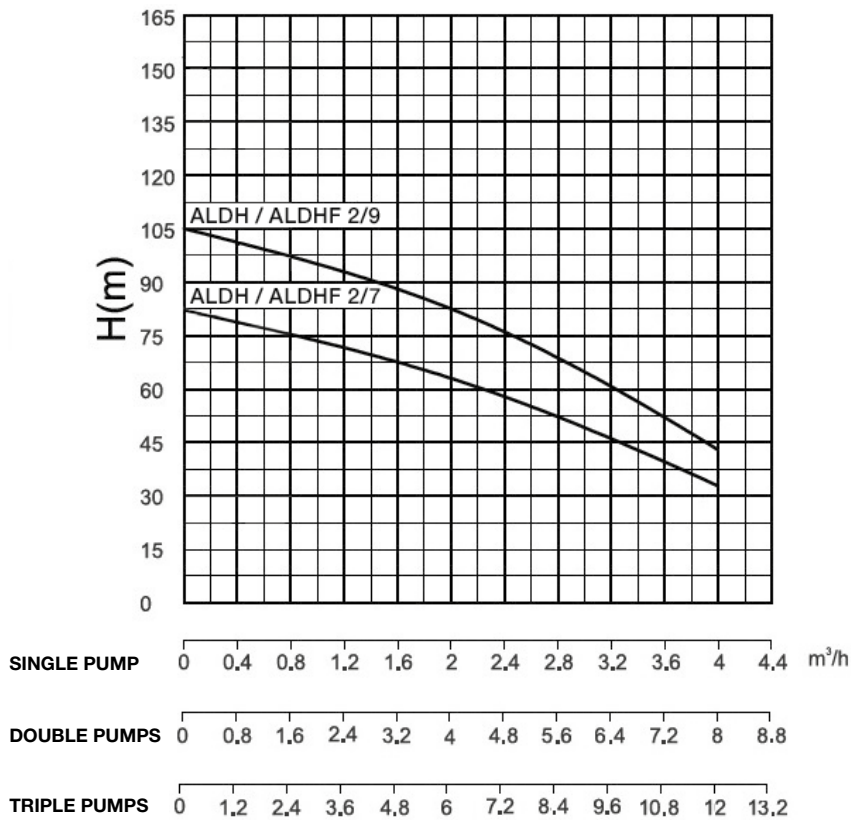
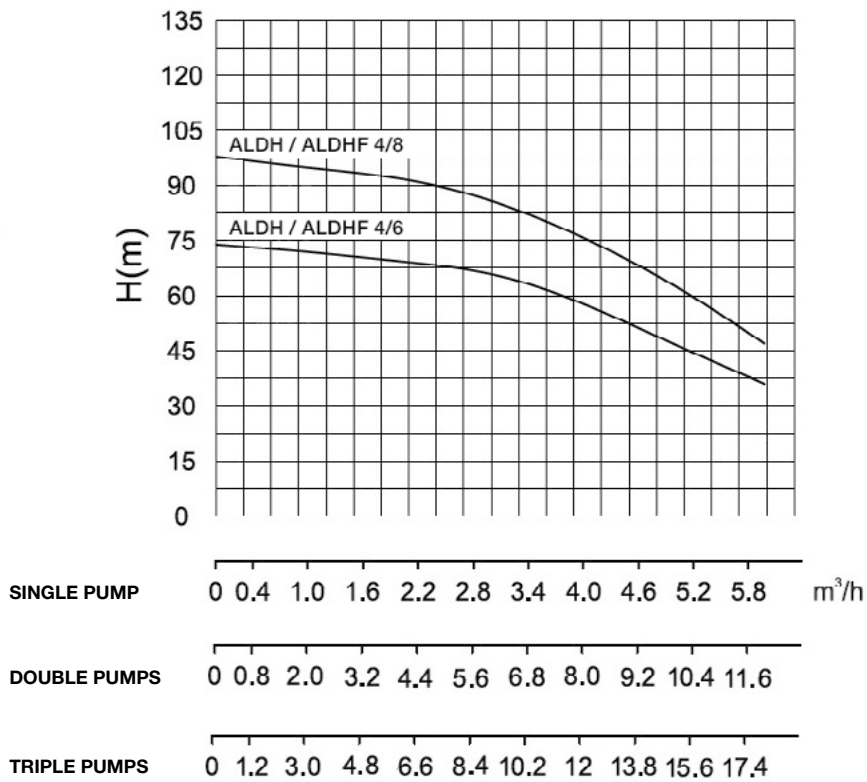

The Right Choice for Different Capacity Requirements



Among the pump systems, water booster systems are the systems in which the capacity varies the most depending on the need.

In the same system, there are cases where the demand varies from 0.1 lt./sec to 10 lt./sec during the day.

Night



NEED: One Glass of Water
0,1 lt./sec.

Morning



NEED: Shower
1 lt./sec.

Noon



NEED: Garden Irrigation
10 lt./sec.

Change of Curve in Pump with Changed Speed

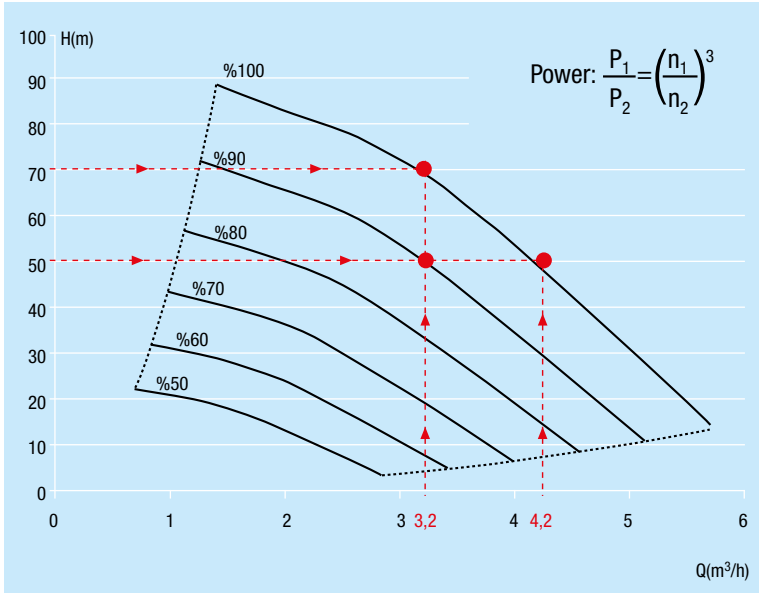

With ALDH Water Boosters High Saving

Booster pumps generally operate at lower capacities than their maximum capacity which is the basis for their selection. As can be seen in the table below, booster pumps operate with 50% capacity in 84% of their annual operating periods and with 25% capacity in 51%.

For this reason, a very high energy saving is achieved with the use of frequency inverters.

The savings made with the use of inverters in standard booster pumps are explained in the table below based on the annual usage rate.

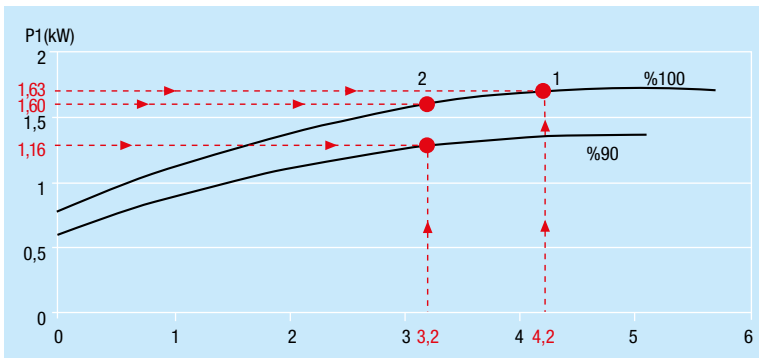

- Pump speed decreases depending on the reduced flow or pressure requirement.
- There is also a lower power draw from the grid due to the lower power requirement.
- Huge energy savings are achieved by decreasing the pump input power. For example, when the pump speed decreases by 10%, energy is saved by 27%.

PERFORMANCE TEST: 1.5 kW Electropump - Constant Pressure (29 mSS)						
Q (lit/sec)	Hm (mSS)	Annual Usage Rate (%)	Input Power (kW)		Difference (kW)	Electrical Saving (kwh / year)
			Standard	F, Inverter		
1,5		7	1,68	1,68	0	0
1,125		9	1,68	0,86	0,82	646
0,75	29	33	1,53	0,69	0,84	2,428
0,375		51	1,23	0,44	0,79	3,529
Total Annual Energy Savings						6,604



Selection Method

The required pressure (Hm) and the required flow rate (Q) values must be known for the selection of the booster pump. Finding Hm and Q values:

$$\text{Required Pressure} = H_{\text{min}} (\text{mSS}) = h + \Delta h + 15$$

h- The height (meters) between the location of the booster pump and the top use floor

Δh - Pressure loss caused by factors in the installation such as armature, water meter, calcified pipe. Δh is considered to be 20% of the height (h).

$$\Delta h = 0.2 h$$

15 - The value found based on the pressure that should be at the highest use height. For example; 15 meters for 1.5 bar pressure. This value also changes if the desired pressure changes.

$$\text{Required Flow Rate} = Q (\text{m}^3/\text{h}) = \text{Number of People Using Water} \times \text{Personal Daily Consumption} \times F/1000$$

Number of people using water:

- For apartment blocks = number of flats x number of people in each flat
- For hotels, barracks, and hospitals = number of beds
- For schools and kindergartens = total number of employees

Personal Daily Consumption (liters/day) value is selected from table 1. The F-Synchronous Usage Factor indicates that users are most likely to use water at the same time. It is selected from Table 2.

Table 1: Water Consumption Per Person For Sample Locations

Residence Type		Daily Consumption Per Person (lt/person)
Residences	With sink	60-80
	Shower	80-115
	Bathtub	120-200
Hotel	Shower	100
	Bathtub	150-200
Hospital		200-500
School		5
Kindergarten		80-100
Nursery		100-150
Barrack		60-80
Restaurant		10-20
Garden Irrigation		1.5 lt/m ² at one go
Car Wash		100 lt/day

Table 2: Synchronism Factor for Water Consumption Per Person

Residence Type		Factor
Residents	1 -5 flats	0.66
	6-10 flats	0.45
	11 -20 flats	0.40
	21 -50 flats	0.35
	51 -100 flats	0.30
Hotels	Above 100 flats	0.25
	1-20 beds	0.40
	21-50 beds	0.40-0.30
Hospitals	Above 50 beds	0.30-0.20
	50-500 beds	0.30-0.20
	501-1000 beds	0.20-0.15
	1001-2000 beds	0.15-0.10
Schools		0.30
Kindergartens		0.40
Barracks		0.40-0.30
Business Centers		0.30

Selection Sample 1:

Selection of a booster pumps for a 7-floor and 21-flat residence.

Calculation of the required pressure: h = (7 floors+1 basement) x 2.8 m (a floor height) = 22.4 m $\Delta h = 0.2 \times h = 0.2 \times 22.4$ meters = 4.48 meters

Required Min. Pressure = Hmin = 22.4 + 4.48+15=41.88 mSS=4.1 bar The Number of Flats =21

Daily Consumption per Person = 100 liters/day (selected from table 1).

F - Synchronism Factor = 0.35 (selected from Table 2)

Required Flow Rate = Q = 21x5x100x0.35/1000 = 3.6 m³/h

(When calculating the flow rate, it is assumed that 5 people live in each flats.)

Water Boosters Selection:

According to the calculation above, ALDH/ALDHF 4/6-1 or ALDH/ALDHF 2/7-2 models can be selected with a pressure range of 40-60 meters or 40-70 meters and an average flow rate of 3.5 m³/h in this pressure range.

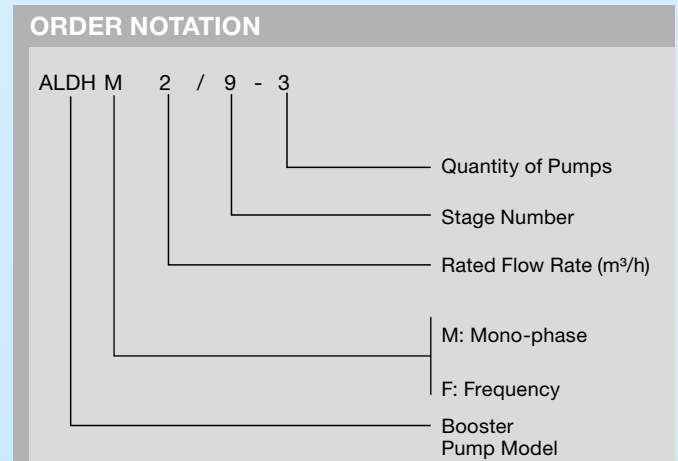

Selection Criteria

- When determining the water boosters, the operating range should be set so that it is at the top of the pump efficiency curve.
- Double or triple pump water boosters can be used instead of single pump booster pumps. In this case, there is no noise and pressure fluctuation caused by the activation and output of a large pump, and the demurrage current decreases. Instead of a single booster pump with a flow rate of 6 m³/h, double pump with each pump of 3 m³/h or triple pump with each pump of 2 m³/h can be selected.
- Multi-pump water boosters can operate as a back-up water boosters if the conditions are favorable. For this, even if a pump is disconnected, other pumps should be able to give the required flow rate. For example, if the flow rate requirement is 6 m³/h, double pump with each pump with a flow rate of 6 m³/h or a booster pump with triple pump with each pump with a flow rate of 3 m³/h can be selected.
- Mains voltage (three-phase/monophase) should be taken into account in the selection of the booster pumps. If there is a monophase mains, a selection should be made from monophase motor models.

Membrane Pressure Compensation Tank and Selection

It must be used with the booster pumps.

- By storing pressurized water, the number of inlets and outlets of the pumps is reduced.
- Absorbs pressure shocks that may occur in the installation.
- It is not included in the booster pump set.
- Tanks with 100 liters and above have a manometer.
- The pressure of the water in the installation can be monitored from the manometer while the booster pump is in operation.
- If the water inside the tank is drained, the manometer shows the pressure of the air in the tank.
- The operating pressure of the tank should be equal to or greater than the pressure that the pump is off or will give in the event of valve.



Tank Selection

The tank volume ($V_{\text{tank-lt}}$) is found by the following formula:

$$V_{\text{tank}} = 0,33 \times Q_{\text{max}} \times \frac{(P_{\text{max}} + 1)}{\Delta P \times a}$$

Q_{max} - The maximum flow rate that the pump can give to the system or the peak flow rate (lt/h) required for the place of use

P_{max} - Maximum pressure (bar) in the system. In residential applications it's sufficient that the pressure is 2-3 bar higher than the minimum pressure.

P_{min} - Minimum pressure in the system (bar). If the value is unknown, it is calculated by formula.

AP - Pressure difference ($P_{\text{max}} - P_{\text{min}}$).

A - Maximum number of stop-start (switch) allowed in 1 hour of pump life (number-hour)

(In the "1999 Unit Price and Recipes Book" of the Ministry of Public Works, this number is given as max. 180 times/h for motors up to 1.1 kW and max. 40 times/h for motors above 1.1 kW.

V_{tank} is the minimum tank volume. A tank larger than these values can be used.

As the tank volume increases, the pressure fluctuation in the water decreases, the activation and deactivation sounds of the booster pump decrease, the life of the engine is prolonged, and the energy consumption decreases.

In industrial applications where the water consumption flow rate is more standardized than social use, a smaller tank can be selected.

Selection Sample:

Finding the required membrane tank volume and pressure for a residence with 7 floors and 21 flats.

$Q_{\text{max}} = 360$ l/h /See Booster Pump Selection, sample 1)

$P_{\text{max}} = 6$ bar

$AP = 2$ or 3 bar can be taken.

Assuming it as 2 bar

Assuming $a = 40$.

$V_{\text{tank}} = 0.33 \times 3,600 \times \frac{(6+1)}{2 \times 40} = 103.9$ lt.

The 100-liter tank can be selected.

For ALDF tank selection, the tank capacity in the above calculation should be multiplied by 0.1.

Correct Assembly

- Suction should not be performed from the bottom level of the water booster. The tank should be next to the water booster and at the same level.
- The water booster must be connected directly to the water mains.
- The pumps should not have difficulty in water suction. Therefore, the water booster pump suction diameters should never be reduced. In single pump water booster, the pump must be one size larger than the water inlet value and regarding double or triple pumps, a suction installation must be installed in the diameter of the suction collector.
- Inner diameters of plastic pipes are narrower than galvanized pipes. If a plastic pipe is to be used, the size providing the inner diameter of the galvanized pipe must be used.
- The pedestal of the water booster should be fixed on the ground (if possible on rubber wedges) to prevent noise. The installation load must not be transported to the water booster.

THE SAMPLE OF WATER BOOSTERS INSTALLATION

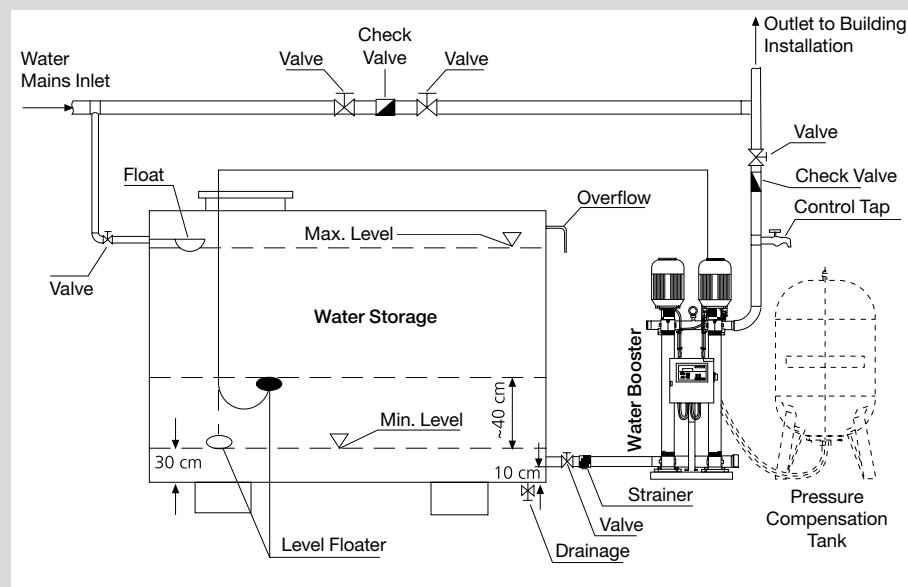

Dimensions

MODEL	A	B	C	D	H	H1	H2
ALDH/ALDHF 2/7X1 MNF	440	450	288	252	710	330	80
ALDH/ALDHF 2/9X1 MNF	440	450	288	252	710	330	
ALDH/ALDHF 2/7X2 MNF	600	376	353	358	1075	355	
ALDH/ALDHF 2/9X2 MNF	600	376	353	358	1075	355	
ALDH/ALDHF 4/6X1 MNF	440	450	288	252	710	330	
ALDH/ALDHF 4/6X2 MNF	600	376	353	358	1075	355	
ALDH/ALDHF 4/6X1 TRF	440	450	288	252	710	330	
ALDH/ALDHF 4/6X2 TRF	600	376	353	358	1075	355	
ALDH/ALDHF 4/6X3 TRF	900	382	353	987	1080	355	
ALDH/ALDHF 4/8X1 TRF	440	450	288	252	710	330	
ALDH/ALDHF 4/8X2 TRF	600	376	353	358	1075	355	
ALDH/ALDHF 4/8X3 TRF	900	382	353	358	1080	355	

All Measurements are in mm.

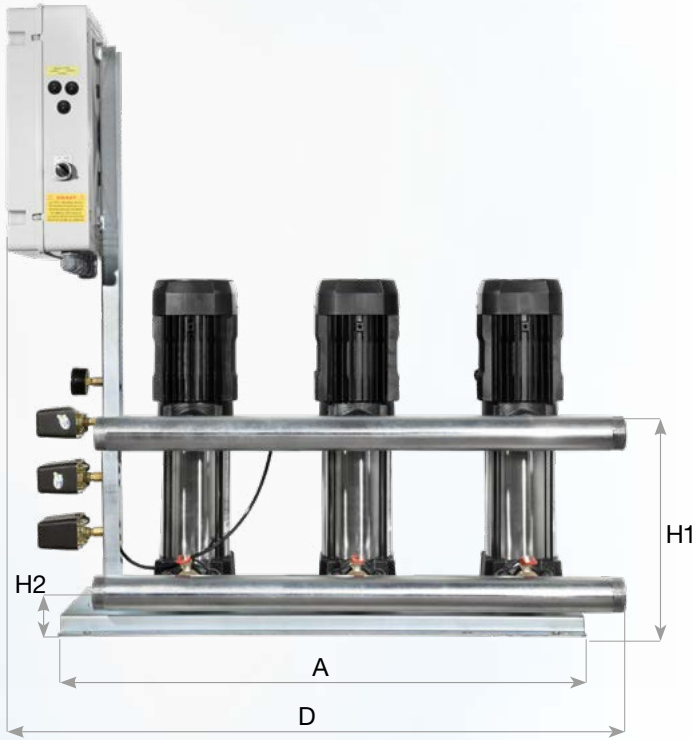

EP_AC_0444

Manufacturer reserves the right to change any product specifications without notice.

ALARKO



**ALARKO CARRIER
SANAYİ VE TİCARET A.Ş.**

GOSB-Gebze Organize Sanayi Bölgesi
Şahabettin Bilgisu Cad. 41480 Gebze-Kocaeli/TURKEY

Phone : (90)(262) 648 60 00 PBX

Telefax : (90)(262) 648 61 01

web : www.alarko-carrier.com.tr

e-mail : info@alarko-carrier.com.tr

D.3.1.13/26122023 MİNERAL