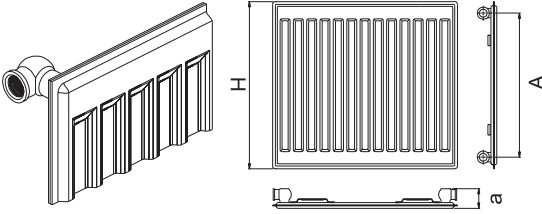
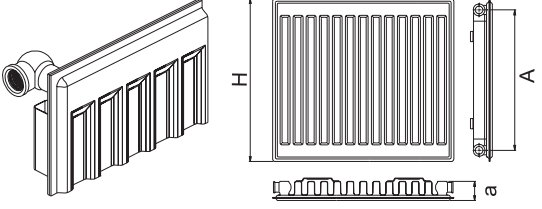

**TİP 10 P**

Standart genişlik: a= 48 mm.

**TİP 11 PK**

Standart genişlik: a= 48 mm.

**TİP 21 PKP**

Standart genişlik: a= 67 mm.

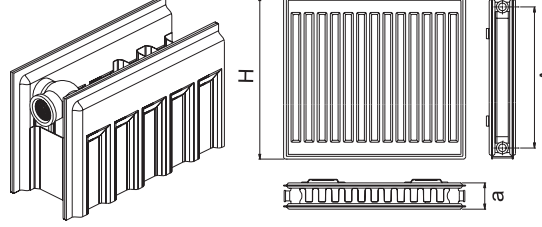
**TİP 22 PKKP**

Standart genişlik: a= 105 mm.

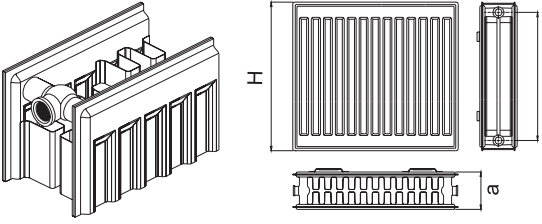
**TİP 33 PKPKP**

Standart genişlik: a= 160.5 mm.

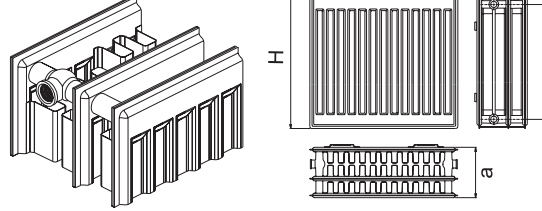

TİP	BOYUTLAR (mm)		AĞIRLIK (kg/m)	SU HACMİ (Lt/m)
	YÜKSEKLİK (H)	A		
TİP 10 P	300	245	6,4	1.8
	400	345	8,3	2.1
	500	445	9,9	2.5
	600	545	11,7	2.8
	750	695	14,5	3.4
TİP 11 PK	300	245	9,2	1.8
	400	345	12,6	2.1
	500	445	15,3	2.5
	600	545	18,3	2.8
	750	695	20,8	3.4
TİP 21 PKP	300	245	27,1	4.0
	400	345	14,3	3.6
	500	445	19,0	4.2
	600	545	24,1	5.0
	750	695	29,0	5.6
TİP 22 PKKP	300	245	36,3	6.8
	400	345	43,7	8.0
	500	445	32,3	4.2
	600	545	32,8	5.6
	750	695	41,0	6.8
TİP 33 PKPKP	300	245	48,6	8.0
	400	345	54,5	8.4
	500	445	63,8	10.2
	600	545	24,5	5.4
	750	695	32,5	6.3

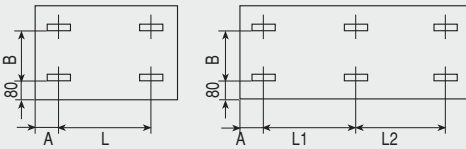
**ASKI SACI ÖLÇÜLERİ**

400-1700 mm uzunluklar için

TİP	A
10-21-22-33	100
11	116.5

L= Radyatör Uzunluğu - 2xA

RADYATÖR YÜKSEKLİĞİ	B
300	115
400	215
500	315
600	415
750	565
900	715

1800-3000 mm uzunluklar için

RADYATÖR UZUNLUĞU	TİP: 10-21-22-33		TİP: 11	
	L1	L2	L1	L2
1800	800	800	766.5	800
2000	900	900	866.5	900
2200	1000	1000	966.5	1000
2400	1100	1100	1066.5	1100
2600	1200	1200	1166.5	1200
2800	1300	1300	1266.5	1300
3000	1400	1400	1366.5	1400

**ASKI KÖŞEBENTİ ÖLÇÜLERİ**

300 mm yükseklik için

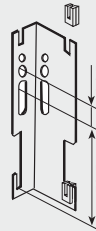

400-500-600-900 mm yükseklikler için

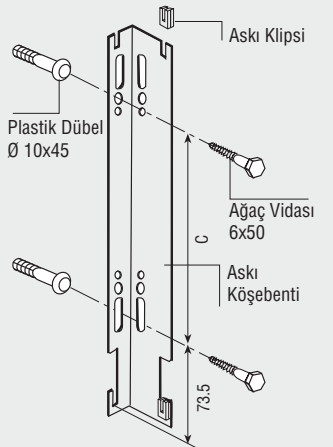

Askı sacı ihtiyaca göre dar veya geniş tarafı duvara gelecek şekilde monte edilebilir.

RADYATÖR YÜKSEKLİĞİ	C
400	92.5
500	192.5
600	292.5
750	442.5
900	592.5

Bütün ölçüler mm'dir.

PANEL RADYATÖR ISIL GÜÇ DEĞERLERİ (WATT) - TS 4310									PANEL RADYATÖR ISIL GÜÇ DEĞERLERİ (kcal/h) - TS 4310								
TİP	Yükseklik (mm)	90/70°C (Ortalama Su Sıcaklığı 80°C)								90/70°C (Ortalama Su Sıcaklığı 80°C)							
		ODA SICAKLIĞI								ODA SICAKLIĞI							
		10	12	15	18	20	22	24	26	10	12	15	18	20	22	24	26
10-P	300	582	561	530	497	477	454	433	415	500	482	456	427	410	390	373	357
	400	745	718	678	636	611	582	555	531	640	618	583	547	525	500	477	457
	500	908	876	827	775	744	709	677	647	780	753	711	667	640	610	582	557
	600	1064	1026	969	909	872	831	793	758	915	882	833	781	750	714	682	652
	750	1310	1263	1193	1119	1074	1023	977	933	1126	1086	1026	962	923	880	840	803
11-PK	300	900	876	827	775	744	709	677	647	1335	1288	1217	1141	1095	1043	995	952
	400	1187	1145	1082	1014	973	927	885	846	798	769	727	681	654	623	595	569
	500	1398	1349	1274	1194	1147	1092	1042	997	1021	985	930	872	837	797	761	728
	600	1637	1579	1491	1398	1342	1278	1220	1167	1202	1160	1096	1027	986	939	896	857
	750	1959	1890	1785	1674	1607	1530	1460	1397	1407	1358	1282	1202	1154	1099	1049	1003
21-PKP	300	2286	2206	2083	1953	1875	1785	1704	1630	1685	1625	1535	1439	1381	1315	1255	1201
	400	1397	1348	1273	1193	1146	1091	1041	996	1966	1896	1791	1679	1612	1535	1465	1402
	500	1747	1686	1592	1493	1433	1365	1303	1246	1201	1159	1094	1026	985	938	895	857
	600	2123	2048	1934	1814	1741	1658	1583	1514	1502	1449	1369	1283	1232	1173	1120	1071
	750	2462	2375	2243	2103	2019	1923	1835	1756	1826	1761	1663	1559	1497	1426	1361	1302
22-PKKP	300	2491	2404	2270	2128	2043	1946	1857	1777	2117	2042	1929	1808	1736	1653	1578	1510
	400	3349	3230	3051	2860	2746	2615	2496	2388	2491	2404	2270	2128	2043	1946	1857	1777
	500	3787	3724	3526	3312	3192	3053	2922	2796	2879	2778	2623	2459	2361	2249	2146	2053
	600	4225	4147	3927	3692	3552	3403	3253	3107	2879	2778	2623	2459	2361	2249	2146	2053
	750	4663	4575	4335	4080	3929	3759	3598	3441	3375	3250	3065	2882	2762	2643	2525	2408
33-PKKPKP	300	5076	4888	4609	4335	4154	3975	3798	3623	3626	3498	3303	3097	2973	2831	2703	2585
	400	5673	5463	5152	4845	4643	4443	4245	4049	2224	2142	2020	1899	1820	1742	1664	1587
	500	6270	6049	5727	5405	5183	4961	4739	4517	2897	2790	2631	2474	2371	2269	2168	2068
	600	6867	6635	6303	5971	5749	5527	5305	5083	3375	3250	3065	2882	2762	2643	2525	2408
	750	7464	7221	6889	6557	6335	6113	5891	5669	3910	3765	3551	3339	3200	3062	2926	2790

PANEL RADYATÖR ISIL GÜÇ DEĞERLERİ (WATT) - DIN EN 442									PANEL RADYATÖR ISIL GÜÇ DEĞERLERİ (kcal/h) - DIN EN 442								
TİP	Yükseklik (mm)	75/65°C (Ortalama Su Sıcaklığı 70°C)								75/65°C (Ortalama Su Sıcaklığı 70°C)							
		ODA SICAKLIĞI								ODA SICAKLIĞI							
		10	12	15	18	20	22	24	26	10	12	15	18	20	22	24	26
10-P	300	405	388	362	337	321	305	289	273	349	334	312	290	276	263	249	235
	400	515	493	461	429	408	387	366	346	443	424	397	369	351	333	315	298
	500	626	599	559	520	495	469	444	419	539	516	481	448	426	404	382	361
	600	739	707	660	613	583	553	523	494	636	609	568	528	502	476	450	425
	750	914	874	815	757	719	682	645	608	787	752	701	652	619	587	555	523
11-PK	300	1098	1050	978	908	862	817	772	728	945	904	842	782	742	703	664	627
	400	653	624	582	540	513	486	460	434	562	537	501	465	442	418	396	374
	500	843	806	752	698	663	628	594	560	726	694	647	601	571	541	511	482
	600	1198	1146	1069	993	944	895	846	798	881	843	787	731	694	658	622	587
	750	1446	1384	1291	1200	1140	1081	1023	965	1031	986	920	855	813	770	728	687
21-PKP	300	1680	1608	1501	1395	1326	1258	1190	1123	1245	1191	1111	1033	981	930	881	831
	400	942	900	839	778	738	699	660	622	1446	1384	1292	1201	1141	1083	1024	967
	500	1201	1148	1070	993	942	892	843	794	811	775	722	670	635	602	568	535
	600	1441	1378	1284	1192	1132	1072	1013	955	1034	988	921	855	811	768	726	683
	750	1665	1592	1484	1378	1309	1240	1172	1106	1240	1186	1105	1026	974	923	872	822
22-PKKP	300	1886	1826	1759	1634	1552	1472	1392	1313	1433	1370	1277	1186	1127	1067	1009	952
	400	2247	2150	2006	1865	1772	1681	1590	1501	1696	1623	1514	1406	1336	1267	1198	1130
	500	2577	2470	2326	2185	2092	2001	1910	1821	1934	1851	1727	1605	1525	1447	1369	1292
	600	2938	2831	2687	2546	2453	2362	2271	2182	1082	1034	963	893	848	803	759	715
	750	3300	3193	3049	2908	2815	2724	2633	2542	1384	1323	1233	1144	1086	1029	973	917
33-PKKPKP	300	3849	3681	3432	3187	3026	2867	2710	2556	1668	1595	1486	1381	1311	1241	1173	1106
	400	4421	4228	3943	3662	3478	3296	3117	2940	1937	1851	1727	1604	1523	1443	1364	1286
	500	4993	4790	4505	4220	4036	3853	3670	3487	2312	2211	2062	1916	1820	1725	1631	1539
	600	5565	5362	5077	4792	4608	4425	4242	4059	2657	2543	2372	2204	2094	1986	1879	1772
	750	6137	5934	5649	5364	5180	4997	4814	4631	2987	2873	2692	2504	2394	2286	2178	2071

\*Kapasite değerleri üst ve yan kapaklar olmaksızın ölçülmüştür.

Isıl güç değerleri 1 metre radyatör boyu için verilmiştir.